

**TENDER NO: 2/2019 Dated 24/6/2019**  
**INVITATION OF TENDERS for**  
**PACKAGE II**  
**WORKS OF HVAC FOR IIITD INNOVATION & INCUBATION CENTRE**



**IIITD**  
**Innovation &**  
**Incubation Center**

**ARCHITECTS**



**SIKKA ASSOCIATES**

A-2/1, Africa Avenue  
Safdarjang Enclave  
New Delhi – 110029  
PH. : 26107053, 43235235  
FAX : 26194481  
E-Mail : [saa@saaindia.net](mailto:saa@saaindia.net)

**INDEX**

S. No.	SUB HEAD	PAGE NO.
1	TENDER DOCUMENT	3 - 50
2	SCHEDULE OF QUANTITIES	attached
3	SPECIFICATION /LIST OF MAKES/ DRAWINGS	attached
4	AGREEMENT PERFORMA	attached

## IIIT Innovation & Incubation Center, New Delhi (IIIC)

DATED: 24.06.2018

### TENDER NOTICE

- |  |                           |
|--|---------------------------|
| 1. Date & Time of issue of tender documents from | 24.06.2019                |
| 2. Last Date & Time of receipt of tender         | 09.07.2019 upto 3.00 p.m. |

CEO, IIITD Innovation & Incubation Center, Okhla, New Delhi-110020 invites sealed item rate tenders from eligible contractors for similar works.

**Name of work: Works of HVAC for the IIITD Innovation & Incubation Centre (IIIC), a section (8) company promoted by IIIT Delhi, Okhla Industrial Area, Phase III, New Delhi 110020.**

Location:	<b>5<sup>th</sup> floor of Lecture Hall Complex</b>
Estimated cost of work put to tender	Rs. 19 Lacs
Time of completion	3 Months

Earnest Money Deposit: **Rs. 38,000/- (Rupees Thirty eight thousand only)** is to be submitted with tender document as earnest money. The above payment shall be made in the shape of deposit at pay order/demand draft of a scheduled bank issued in favour of **IIITD Innovation & Incubation Center** payable at New Delhi.

Works to be completed in coordination with the main interior works contractor. No extra for non-availability of fronts or coordination with main agency shall be payable on account of the same.

Tender documents can be downloaded from IIITD website ([www.iiitd.ac.in](http://www.iiitd.ac.in)) and submitted with non refundable DD of Rs. 500/- in favour of **IIITD Innovation & Incubation Center** as cost of tender.

- 1) The tenders shall be placed in sealed envelopes with a name of work and due date written on the envelope and addressed to CEO, IIITD Innovation & Incubation Center. Complete tender documents shall be submitted by the approved contractors in two envelopes. First envelope shall contain the earnest money in the shape of Demand Draft / Pay Order of a scheduled Bank requisite shape as per condition & eligibility criteria and cost of tender as stated above in case of the downloaded version.
- 2) The eligible contractors who have carried out similar works in IIIT-D/ Govt Deptts/ PSU/ Reputed Pvt sector/ MNCs are to submit the experience certificates for the works and registration certificates with Govt. Depts. if any. The said certificates along with the EMD be enclosed in Envelope-1.
- 3) Experience of having successfully completed similar works during last seven years ending on the 31<sup>st</sup> May 2019. The Similar works shall mean works of Heating Ventilation and Air-conditioning works. The value of executed works shall be brought to current costing level by enhancing the actual value of work at simple rate of 7% per annum calculated from date of completion to last date of receipt of tenders.

Three similar works not less than 40% of est.cost	Rs 7.6 lacs each Or
Two similar works not less than 60% of est cost	Rs 11.4 lacs each Or
One similar work not less than 80% of est cost	Rs 15.2 lacs each

- 4) One completed works of any nature either part of 3) or separate one costing not less than 40% of estimated cost ie Rs 7.6 lacs with some Central/State/Autonomous/Central PSU/State PSU/local authority formed under any Act published in Central/State Gazette.
- 5) The applications not supported with requisite experience certificates, GST registration certificate, TIN no. and ITCC in Envelope-1 shall not be entertained
- 6) Average Annual Turnover over HVAC works should be at least Rs 48 lacs during immediate last 3 consecutive financial years ending 31<sup>st</sup> Mar 2019.

- 7) Should not have incurred any loss in the more than two years in the last five years ending 31<sup>st</sup> Mar 2019.
- 8) Should submit solvency certificate of 40% of estimate ie for 7.6 lacs from their bankers.
- 9) Performance certificates must be submitted by the vendors for the works.
- 10) A pre-bid conference would be held on the **1<sup>st</sup> July 2019** at 10AM at the 5<sup>th</sup> Floor of Lecture Hall Complex.
- 11) The second envelope shall contain the financial bids including Priced Schedule of Quantities, Form of Tender, Conditions of Tender, Articles of Agreement, Brief Specifications, Condition of contract, Drawings all duly signed by the authorized signatory of the firms.
- 12) All these envelopes are to be put in a single envelope duly super-scribed the name of work, and addressed to CEO, IIITD Innovation & Incubation Center and with their address. In case the tenderer does not fulfill the laid down eligibility criteria or fails to deposit the earnest money in prescribed form, financial bid shall not be opened.
- 13) Tenderers shall seal the tender affix their initials and put stamp on each and every page of tender document before submission. The tender of the contractor, who submits in-complete tender document or submits more than one tender for one work, shall not be considered at all.
- 14) Tenders will be received by the **CEO up to 3.00 P.M on 09/07/2019** and will be opened by him or his authorized representative in the office of Registrar, IIITD on the same day at 3.30 P.M.
- 15) First the Technical Bids will be opened and screened. The bids shall be examined whether the EMD is in order and the bidder meets the minimum eligibility criteria specified above. Those bidders whose EMD is in order, meets the minimum eligibility criteria, has submitted all the required documents and meet the technical requirements shall be considered for opening of financial bid. Conditional tenders would not be accepted. Financial bids in respect of contractors who do not fulfill above criterion shall not be opened.
- 16) No Xerox / certified copies of tenders shall be accepted, if submitted these tenders shall be rejected.

**CEO, IIITD Innovation & Incubation Center**

## CONDITIONS

1. The time allowed for carrying out the construction work will be 3 months from the 3rd day after the date of written orders to commence the work.
2. The site for the work is available.
3. During execution of works, because of some unforeseen circumstances to enable him to complete the work as per terms of the contract, shall not relieve the contractor from any liability or obligations under the contract and he shall be responsible for the acts, defaults and neglects of any sub-contractor, his agents or workmen as fully as if they were the acts, defaults or neglects of the contractor, his agents or workmen.
4. The Contractor shall be required to deposit an amount equal to 5% of the tendered value of the work as performance guarantee in the form of an irrevocable bank guarantee bond of any scheduled bank or State Bank of India in accordance with the form prescribed or in the form of fixed deposit receipt etc. within 4 days of the issue of letter of acceptance. The performance guarantee shall have the validity up to 31st December 2019.
5. Tenderers are advised to inspect and examine the site and its surrounding at their own cost and satisfy themselves before submitting their tenders as to the nature of the ground and sub-soil (so far as is practicable), the form and nature of the site, means of access to the site, the accommodation they may require and in general shall themselves obtain all necessary information as to risk, contingencies and other circumstances which may influence or affect their tender. A tenderer shall be deemed to have full knowledge of the site whether he inspects it or not and no extra charges consequent on any misunderstanding or otherwise shall be allowed. The tenderer shall be responsible for arranging and maintaining at own cost all materials, tools and plants, water, electricity, access, facilities for workers and all other services required for executing the work unless otherwise specifically provided for in the contract documents. Submission of a tender by a tenderer implies that he has read this notice and all other contract documents and has made himself aware of the scope and specification of the work to be done, local condition and other factors having a bearing on the execution of the work.
6. The Accepting Authority (IIIC) does not bind himself to accept the lowest or any other tender and reserves to him/herself the authority to reject in whole or part, any or all of the tenders received without the assignment of any reason. All tenders in which any of the prescribed conditions are not fulfilled or for any condition including that of conditional rebate is put forth by the tenderer shall be summarily rejected.
7. Canvassing, whether directly or indirectly, in connection with tenders is strictly prohibited and the tenders submitted by the contractor who resort to canvassing will be liable to rejection.
8. The Accepting Authority reserves to himself the right of accepting the whole or any part of the tender and the tender shall be bound to perform the same at the rates quoted.
9. Tenders shall remain open for acceptance for a period of 60 days from the date of opening of the tenders. If any tenderer withdraws his tender before the said period for issue of letter of acceptance, whichever is earlier or makes any modification in the terms and condition of the tender which are not acceptable to the IIIC, then IIIC shall, without prejudice to any other right or remedy, be at liberty to forfeit 50% of the said earnest money absolutely besides black listing of the tenderer.
10. The notice inviting tender shall form a part of the contract document. The successful tenderer/contractor shall, sign the necessary contract documents consisting of the notice inviting tender, all the documents including additional conditions, specification and drawings, if any forming the tender as issued at the time of invitation of tender and acceptance thereof with any correspondence leading thereto within the time specified in the letter communicating the acceptance of the tender. In case of delay, the earnest money may be forfeited and the tender cancelled or the contract enforced as per the terms of the tender and the invitation to tender and the tenderer shall thus be bound by the condition of contract even though the formal agreement has not been executed and signed within the specified time by the tenderer.
11. The work shall be carried out as per general conditions of contract for central PWD works 7/8 (Tender Contract) and form part of the agreement/document.
12. Contract is liable to be terminated by the IIIC without payment of any compensation, if subsequent to the acceptance of tender the contractor is black-listed by, or enters into partnership or employs any black listed contractor of the IIIC or any other department, or Govt. or its, undertakings.
13. **Cost of Bidding:** The bidder shall bear all costs associated with the preparation and submission of his Bid, and the Employer will in no case be responsible and liable for those costs.

- 14. Clarification of Bidding Documents:** A prospective bidder requiring any clarification of the bidding documents may notify the Employer in writing/mail at the Employer's address indicated in the invitation to bid not later than 5 days before the Date of Submission of Tenders.

**Email: ceo@iiitdic.in**

- 15. Currencies of Bid and Payment:** The unit rates and the prices shall be quoted by the bidder entirely in Indian Rupees. All payments will be invariably made in Indian Currency (Indian Rupees.)
- 16. Protection of Environment and Other Laws:** The contractor shall take all reasonable steps to protect the environment on and off the Site and to avoid damage or nuisance to persons or to property of the public or others resulting from pollution, noise or other causes arising as a consequence of his methods of operation.
- 17.** During continuance of the contract, the contractor and his sub-contractors shall abide at all times by all existing enactments on environmental protection and other local Acts/ Laws/ rules made there under, regulations, notifications and bye-laws of local authorities or any other law, bye-laws, regulations that may be passed or notification that may be issued in this respect in future by the State/ Local authority.

For and on behalf of

IIITD Innovation & Incubation Center New Delhi

**TENDER**

I/We have read and examined and understood the notice inviting tender, schedule, A, B, C, D, E & F, Specifications applicable, drawings & Designs, General Rules and Directions, Conditions of Contract, clauses of contract, special conditions, Schedule of Rate & other documents and Rules referred to in the conditions of contract and all other contents in the tender document for the work.

I / We hereby tender for the execution of the work specified for the IIITD Innovation & Incubation Center within the time specified in Schedule ' F ', viz., schedule of quantities and in accordance in all respects with the specifications, designs, drawings and instructions in writing referred to in Rule-1 of General Rules and Directions and in Clause 11 of the Conditions of contract and with such materials as are provided for, by, and in respect in accordance with, such conditions so far as applicable.

We agree to keep the tender open for sixty (60) days from the due date of its opening and not to make any modifications in its terms and condition.

A sum of Rs..... Rupees (.....) has been deposited in demand draft of a scheduled bank issued by a scheduled bank as earnest money. If I / we, fail to furnish the prescribed performance guarantee within prescribed period, I / we agree that the said Chairman, IIITD Innovation & Incubation Center or his successors in office shall without prejudice to any other right or remedy, be at liberty to forfeit the said earnest money absolutely. Further, if I / we fail to commence work as specified, I / we agree that Chairman, IIITD Innovation & Incubation Center or his successors in office shall without prejudice to any other right or remedy available in law, be at liberty to forfeit the said earnest money and the performance guarantee absolutely, otherwise the said earnest money shall be retained by him towards security deposit to execute all the works referred to in the tender documents upon the terms and conditions contained or referred to therein and to carry out such deviations as may be ordered, up to maximum of the percentage mentioned in Schedule ' F ' and those in excess of that limit at the rates to be determined in accordance with the provision contained in Clause 12.2 and 12.3 of the tender form. Further, I / We agree that in case of forfeiture of earnest money or both Earnest Money & Performance Guarantee as aforesaid, I / We shall be debarred for participation in the re-tendering process of the work.

I / We hereby declare that I / we shall treat the tender documents drawings and other records connected with the work as secret / confidential documents and shall no communicate information / derived there from to any person other than a person to whom I / we am / are authorized to communicate the same or use the information in any manner prejudicial to the safety of the State.

Dated. ....

Witness:

Signatures of Contractor

Address:

Occupation:

**LETTER OF SUBMISSION**

The CEO  
IIITD Innovation & Incubation Center  
5<sup>th</sup> Floor, Lecture Hall Complex  
Indraprastha Institute of Information Technology, Delhi  
Okhla Phase-III  
New Delhi-110020.

I/We, the undersigned, have read and examined in detail, the specifications and all bidding documents and hereby declare that:

1. All the rates quoted in our proposal are in accordance with the terms and conditions as specified in the bid document. All the prices and other terms and conditions of this proposal are valid for a period of 60 calendar days from the date of opening of bid.
2. We do hereby confirm that our bid prices include all taxes/levies/however GST is indicated separately.
3. We hereby declare that if any tax law is altered, we shall pay the same.
4. The quoted rates are inclusive of ESI, PF and Green Tax no extra on such heads would be payable on such account.

**Earnest Money**

We have enclosed EMD in the form of demand draft no....., dated.....favoring IIITD Innovation & Incubation Center, Delhi payable at New Delhi issued / drawn on .....Bank for Rs.\_\_\_\_\_/ - (Rupees \_\_\_\_\_ Thousand only), as desired.

**Deviations**

We declare that all the works shall be performed strictly in accordance with the technical specifications and other tender conditions with no deviations.

**Qualifying Data**

We confirm that all information/data have been submitted as required in tender document.

We hereby declare that our proposal is made in good faith, without collusion for fraud and the information contained in the proposal is true and correct to the best of our knowledge and belief. I/We agree that in case any information is found to be incorrect the tender is liable to be rejected at any point of tendering process.

Bid submitted by us is properly sealed and prepared so as to prevent any subsequent alteration and replacement.

We understand that you are not bound to accept the lowest or any bid you may receive.

Thanking you,  
Yours faithfully,  
(Signature and seal of Tenderer with name, designation and contact no.)



**ACCEPTANCE**

The above tender (as modified by you as provided in the letters mentioned hereunder) is accepted by me for and on behalf of CEO, IIITD Innovation & Incubation Center for a sum of

Rs. ----- (Rupees -----)

The documents referred to below shall form part of this contract Agreement:-

- NIT
- Performa for Agreement
- Additional conditions.
- Special conditions
- Schedule of Quantities &
- Drawings
- General conditions of contract for CPWD Works-2012 with up to date correction slip

For & on behalf of  
CEO  
IIITD Innovation & Incubation Center

Signature. ....

Dated.....

Designation.....

## SCHEDULES

<b>SCHEDULE 'A'</b> Schedule of quantities (Enclosed)	Enclosed
<b>SCHEDULE 'B'</b> Schedule of materials to be issued to the contractor	NIL
<b>SCHEDULE 'C'</b> Tools and plants to be hired to the contractor	NIL
<b>SCHEDULE 'D'</b> Extra schedule for specific requirements/documents for the work, if any,	NIL
<b>SCHEDULE 'E'</b> Schedule of component of Cement, Steel, other materials, Labour etc. for price escalation.	NIL
<b>CLAUSE 10 CC</b> Component of Cement - expressed as percent of total value work,	N / A
Component of Steel-expressed as percent of total work.	N / A
Component of civil (except cement & steel) / Electrical construction Materials-expressed as percent of total value of work.	N / A
Component of labour-expressed as per cent of total value of work.	N / A
Component of P.O.L. - expressed as percent of total value work.	N / A
<b>SCHEDULE 'F'</b> Reference to General Conditions of contract.	

Name of Work: **HVAC Works for IIITD Innovation & Incubation Center, IIIT Delhi Campus, at 5th Floor of Lecture Halls Complex, Okhla Phase III , New Delhi.**

Estimated cost of work: Rs.19 lacs

Earnest money: Rs. 38,000/-

- i. **Performance Guarantee:** The contractor, for due and faithful performance of the Contract, shall obtain and submit to the Owner such security of 5% of the Contract Value within 7 days after the receipt of the Letter of Acceptance, in the form of BG Performa as appendix to tender from a scheduled Bank /FD providing such security shall be subject to the approval of the Owner. The cost of complying with the requirement of this Clause shall be borne by the Contractor.

**Period of Validity of performance Bond:** The performance bond shall be valid as at Conditions Cl 4 and till the Contractor has executed and completed the Works in accordance with the Contract. This security shall be returned to the contractor within 14 days of the issue of the said Completion Certificate.

**Claim under Performance Security:** Prior to making a claim under the performance security the Owner shall, in every case, notify the Contractor stating the nature of the default in respect of which the claim is to be made.

**Security Deposit/ Retention money** shall be Five percent (5%) of the value of executed works and will be deducted from each and every payment made to the contractor against running account bill submitted for the work done at site. 50% of retention money will be released along with the payments of final bill and balance 50% will remain with Employer until the Defects Liability period is successfully over.

- ii. Defect Liability period 12 months from date of completion.
- iii. **Liquidated damages:** In case of delay on account of reasons attributable to the Contractor Liquidated Damages shall be levied .The amount of Liquidated Damages payable by the Contractor to the Employer would be 0.25% of the value of order for each calendar day of delay subject to a maximum of 5% of the value of order after which Employer reserves the right to terminate the contract without prejudice to the rights of the Employer.

General Rules & Direction:

Officer inviting tender: CEO, IIITD Innovation & Incubation Center

**Definitions**

2(v) Engineer-in-Charge	To be assigned on award of work
2(viii) Accepting Authority	Chairman, IIITD Innovation & Incubation Center
2(x) Percentage on cost of materials and labour to cover all overheads and profits.	15%
2(xi) Standard Schedule of Rates (Civil and Electrical)	DSR-2016
2(xii) Department	IIITD Innovation & Incubation Center
9(ii) Standard CPWD contract Form correction slips.	CPWD form 8 -2010 with up to date

**Clause 1**

- (i) Time allowed for submission of Performance Guarantee From the date of issue of letter of acceptance 4 days
- (ii) Maximum allowable extension beyond the period 7days

(Provided in (I) above

<b>Clause 2</b> Authority for fixing compensation under clause 2.	Chairman, IIITD Innovation & Incubation Center
<b>Clause 2A</b> Whether clause 2A shall applicable	No
<b>Clause 5</b> Number of days from the date of issue of letter Acceptance for reckoning date of start	3 days
Time allowed for construction	3 months
<b>Clause 6, 6A</b> Clause applicable - (6 or 6A)	Clause 6A
<b>Clause 7</b> Gross work to be done together with net payment /adjustment or advance for material collected, if any since the last such payment for being eligible to interim payment.	Rs 7.5 Lakhs.
<b>Clause 10A</b> List of testing equipment to be provided by the contractor at site lab.	As required
<b>Clause 10 B (ii)</b> Whether Clauses 10B (ii) (iv) shall be applicable -----do-----10B(iii) -----	Yes No
<b>Clause 10CA Escalation</b>	<b>Not Applicable</b>
<b>Clause 10CC Escalation</b>	<b>Not Applicable</b>
<b>Clause 11</b> Specification to be followed for execution of work	CPWD Specifications 2007, Part I & II with Up-to-date correction slips General Specification for HVAC works -2017
<b>Clause 12</b> Deviation limit beyond which clauses 12.2 & 12.3 shall Apply for building work	100%
<b>Clause 16</b>  Competent Authority for deciding reduced rates.	Chairman, IIITD Innovation & Incubation Center
<b>Clause 17</b>  Contractor liable for Damages defects during maintenance period	Applicable
<b>Clause 18</b> List of mandatory machinery, tools & plants to be deployed by the contractor at site	As per the site requirement.
<b>Clause 36(i)</b> Requirement of Technical Representative (s)	As per requirement.
<b>Clause 25</b> Arbitration Clause	As per special conditions

## SPECIAL CONDITIONS

1. In the event of the tender being submitted by a firm, it must be signed by a person duly authorized through a power of attorney issued by all the partners and a certified copy of the power of attorney should be enclosed with the forwarding letter or separately by each member thereof, or in the event of the absence of any partner, it must be signed on his behalf by a person holding a power of attorney authorizing him to do so and such power of attorney shall be produced with the tender and it must disclose that the firm is registered under the Indian partnership Act.

Each and every signature given shall be separately witnessed. A Contractor or a contractor who himself / themselves has/have tendered or who may tender for the work shall not witness the tender of another person for the same work. Failure to observe this condition would render tenders of the contractors tendering as well as witnessing the tenders liable for summary rejection.

2. The conditions for item rate tender only will be applicable as given in general conditions of contract for central PWD works 2010. As mentioned there in also, in event no rate has been quoted for any items leaving space bolts in figure (s), word(s) and amount blank, it will be presumed that the contractor has included the cost of this/these item(s) in other item(s) and rate for such items will be considered as zero and work will be required to be executed accordingly.
3. Rates quoted as percentage below/above in the tender will be summarily rejected.
4. It must be understood that the work has to be completed as per the time provided in the contract and as such time is the essence of the contract.
5. The quantities furnished in the bills of quantities are only probable quantities liable to alternation by omission, deduction or addition, and it would be clearly understood that the contract is **not a lump sum contract** and the IIC do not, in any way, assure the tenderer or guarantee that the said probable quantities are correct or that the work would correspond thereto. Payments will be regulated on the actual quantities of work authorizedly done and measured at the accepted rates. No claims due to change in quantities (+ or -) will be entertained. The drawings, forming parts of complementary installations work specifications and the bills of quantities, of the contract, are explanatory of and are to one another, representing together the works / to be carried out. If neither the drawings nor the specifications nor the accepted bills of quantities include any part/parts the intention to include which is nevertheless clearly inferred and which are obviously necessary for the proper completion of the works/ installations, all such parts shall be supplied and executed by the contractor at no extra charge. Anything contained in one or another of (a) the drawings, (b) the specifications and (c) the accepted bills of quantities and not found in the others will be equally binding as if it were contained in each of them.
6. No alterations, which are made by the tenderer in the drawings, specifications, conditions or probable quantities accompanying this notice will be recognized and if any such alterations are made the tender, will be invalid. Conditional tenders will however be liable for rejection.
7. The tenderer must obtain for himself on his own responsibility and at his own expense all the information necessary, including risks, contingencies and other circumstances to enable him to make a proper tender and to enter into a contract with the IIC. He must examine the drawings, specifications, conditions and so on and must inspect the site of work, examine the nature of the ground and the subsoil (so far as is practicable) and acquaint himself with local conditions, means of access to the work, storage facilities or areas for staff colony, the nature of the work, in fact all matters pertaining thereto before he submits his tender.
8. The tenderer shall also bear all expenses in connection with the preparation and submission of his tender and attendance for subsequent negotiations/clarifications.
  - (I) Omission, neglect or failure on the part of the tenderer to obtain requisite and reliable information on any matter affecting his tender, the contract and the construction, completion, maintenance, (dismantling and disposal) of the work shall not relieve the tenderer whose tender is accepted from any

liability in respect of the contract.

- (II) The tenderer whose tender is accepted shall not be entitled to make any claim for increase in the rates quoted and accepted excepting in pursuance of any specific provision in the contract.
9. The Contractor, upon award of work, shall furnish the following details for the approval of the Engineer in charge:
- 9.1. The names of manufacturers of specialized items such as patented water proofing systems / materials, doors, flooring tiles, false ceilings, insulating materials, wind mill, cement, steel, glazing, and any other materials etc. which he proposes to use in the work.
- 9.2. The makes and types of fittings, materials, subject to the makes and type stipulated in the specifications, which he proposes to use in the work.
- 9.3. The details of licenses granted to him and/or to professional qualified and/or licensed technical personnel on his staff who will be engaged on the work (and submit, if called for, the licenses for inspection by the Officer in charge in consultation with Engineer in charge).
- 9.4. Only approved agencies/ skilled workers shall be deployed to carry out requisite specialized items of work. The Officer/ Engineer in charge's decision in consultation with Architect's/ in this regard shall be binding to all the parties concerned.
10. The rates quoted in the bills of quantities shall unless specified otherwise will be for all heights, depths deemed to be for finished work in-situ/ item by item as provided for, and shall include cost for all necessary material and labours, all necessary tools and plants and machinery, sheds, marking out, clearing site, etc. and for all taxes, octroi, excise, VAT works contract and any other tax or duty levied by Government, Central or Local, Green Tax, ESI and PF. or Local Authority if any as applicable. The GST indicated separately, if any as applicable.
- 10.1. The rates shall be firm and not be subject to any variations in exchange rates, in taxes, duties etc. in railway freight and the like including labour conditions, etc. The rates are not subject to escalation.
11. It will be the sole responsibility of the contractor to procure all the equipments/ materials and other materials required for the work.
13. The IIC further reserves the right to delete or reduce at any time, any section of the bills of quantities with out assigning any reasons whatsoever there for and no claim will be entertained in this regard.
14. The tenderer whose tender is accepted is bound to execute formal agreement with the IIITD Innovation & Incubation Center within one week of the date of intimation of award of work in accordance with the draft agreement which will include conditions of tender, form of tender (general conditions of contract for central PWD works 2010), Articles of Agreement, Bills of quantities, Conditions of contract, Special conditions if any, the drawings and specifications, but his liability under the contract shall commence from the date of written order to commence work whether the formal agreement is drawn or not.
- The Contractor shall bear all expenses in connection with the execution of the said agreement including fees for stamping and registration of documents as required.
15. The Security Deposit will bear no interest what so ever until the date of release.
16. a) The contractor, upon award of work, shall submit a memorandum of procedure giving the outline of his general scheme, programme and time table, in the form of a chart that shall be scrutinized and approved (with modifications as necessary), which shall become the approved programme for execution. The approved programme shall be the basis for assessment of comparative progress under the relevant conditions of contract.
- b) Over and above, the contractor has to supply programme chalked out showing important milestones to be achieved and the progress actually achieved compared with, the target of the same in the programme and shortfall, if any planned for being made up in the programme for next month.

17. (a) The work in general shall conform to the CPWD Specifications 2007 with up to date correction slips & any other latest civil specification published by CPWD, New Delhi and the "Specifications for works".
- (b) In case items not covered by the general specifications referred above, reference shall be made to the appropriate I.S. Code.
- (c) Should there be any difference in the particular specifications of individual item of work and the description of item as given in the Schedule of quantity, the latter shall prevail, which will be as per the relevant drawing.
- (d) In case of any work for which there is no specification in I.S. specifications or in the specifications forming part of tender documents or in case there is any variation, such work shall be carried out in all respects in accordance with the instructions to be issued by the Engineer in charge.

18. On acceptance of the tender the Contractor shall in writing and at once inform the IIIC and the Architects the name of his accredited representative(s) who will be responsible to take instructions from the Architects / Officer in Charge.

The work of any part of it shall not be transferred, assigned or sublet without the written consent of the IIIC.

19. The Contractor shall be required to co-operate and work in co-ordination with and afford reasonable facilities for such other agencies / specialists / interior designers / consultants as may be employed by the Architects / Project Management Consultant/ Officer in Charge on other works / sub-works in connection with the project/scheme of which this work forms a part.
20. The Contractor shall get the necessary insurance done for their personal employed/ company insurance, third party insurance, marine insurance, all risk insurance or any other insurance as required.
21. The Contractor shall make arrangements of carrying water and electricity beyond one point where same shall be provided and recovery @1% of the cost of works shall be effected accordingly.
22. The Contractor is required to comply with all Acts of Government relating to labour, safety, environment and other Rules and Regulations made there under from time to time and to submit at the proper times all particulars and statements required to be furnished to the appropriate Authorities.

**23. Delay and extension of time:** If in the opinion of the Architect/PMC/Owner the Work is delayed:

- a) By force majeure, or
- b) By reason of any exceptionally inclement weather, or
- c) By reason of proceedings taken or threatened by or dispute with adjoining or neighboring owners or public authorities arising otherwise than through the Contractor's own default, or
- d) By the works or delays of other Contractor or tradesmen engaged or nominated by the Owner or the Architect/PMC and not referred to in the Schedule of Quantities and/or Specification, or
- e) By reason of Architect's/PMC/Owner Instructions to delay work, or
- f) By reason of civil commotion, local combination of workmen or strike or lock-out affecting any of the building traders, or
- g) In consequence of the Contractor not having received in due time necessary Instructions from the Architect/PMC/Owner for which he shall have specifically applied in writing,

Then the Architect/PMC/Owner shall make a fair and reasonable extension of time for completion of the Contract Work; in case of such strike or lock-out the Contractor shall, as soon as may be, give written notice thereof to the Architect/PMC/Owner, but the Contractor shall nevertheless constantly use his endeavors to prevent delay and shall do all that may reasonably be required to the satisfaction of the Architect to proceed with the work.

- 24. Failure by Contractor to comply with Architect's Instructions:** If the Contractor after receipt of written notice from the Architect requiring compliance fails within ten days to comply with such further drawings and/ or Architect's Instructions the Owner with the consent of the Architect may employ and pay other persons to execute any such work whatsoever that may be necessary to give effect thereto, and all costs incurred in connection therewith shall be recoverable from the Contractor.

**25. Termination or Abridgment of Contract by the Owner**

- a) If the Contractor being an individual or a Firm commit any 'Act or Insolvency' or shall be adjudged an Insolvent or being an Incorporated Company or Society shall have an order for compulsory winding up made against it or pass an effective resolution for winding up voluntarily or subject to the supervision of the Court and of the Official Assignee of the Liquidator in such acts of insolvency or winding up shall be unable within seven days after notice to him requiring him to do so, to show to the reasonable satisfaction of the Architect that he is able to carry out and fulfill the Contract, and to give security therefore, if so required by the Architect, or
  - b) If the Contractor (whether an individual, Firm, Incorporated Company or Society) shall suffer execution to be issued, or
  - c) Shall suffer any payment under this Contract to be attached by or on behalf of any or the creditors of the Contractor, or
  - d) Shall assign or sublet this Contract without the consent in writing of the Architect/PMC first obtained, or
  - e) Shall charge or encumber this Contract or any payments due or which may become due to the Contractor there under, or
  - f) If the Architect/PMC shall certify in writing to the Owner that the Contractor:
    - i) Has abandoned the Contract, or
    - ii) Has failed to commence the works, or has without any lawful excuse under these Conditions suspended the progress of the works for 14 days after receiving from the Architect/PMC/Owner written notice to proceed, or
    - iii) Has failed to proceed with the works with such due diligence and failed to make such due progress as would enable the works to be completed within the time agreed upon, or
    - iv) Has failed to remove materials from the site or to pull down and replace work for seven days after receiving from the Architect written notice the said materials or work were condemned and rejected by the Architect under these conditions, or
    - v) Has neglected or failed persistently to observe and perform all or any of the acts, matters or things by this Contract to be observed and performed by the Contractor for seven days after written notice shall have been given to the Contractor requiring the Contractor to observe or perform the same, or
    - vi) Has to the detriment of good workmanship or in defiance of the Architect's/PMC Instructions to the contrary sub-let any part of the Contract,
26. Then and in any of the said cases the Owner with the written consent of the Architect/PMC may, notwithstanding any previous waiver, after giving seven days' notice in writing to the Contractor, determine the Contract, but without hereby affecting the powers of the Architect or the obligations and liabilities of the Contract the whole of which shall continue in force as fully as if the Contract had not been so determined and as if the works subsequently executed had been executed by or on behalf of the Contractor. The costs of these works are therefore recoverable from the Contractor. And further, the Owner under instructions of the Architect, by his Agents or servants may enter upon and take possession of the works and all plants, tools, scaffolding, sheds, machinery, steam and other power utensils and materials lying upon the premises or the adjoining lands or roads, and use the same as his own property or may employ the same by means of his own servants and workmen in carrying on and completing the works or by employing any other Contractor or other person or persons to complete the Work, and the Contractor shall not in any way interrupt or do any act, matter or thing to prevent or hinder such other Contractor or other person or persons employed for completing and finishing or using the materials and plant for the Work. When the Work shall be completed or as soon thereafter as convenient the Architect shall give a notice in writing to the Contractor to remove his surplus materials and plant, and should the Contractor fail to do so within a period of 14 days after receipt thereof by him, Owner shall sell the same, and shall give credit to the Contractor for the amount realized. The Architect shall thereafter ascertain and certify in writing what (if anything) shall be due or payable to or by the Owner for the value of the said plant and materials so taken possession of by the Owner and the expense or loss which the Owner shall have been put to in procuring the works to be



completed, and the amount, if any, owing to the Contractor and the amount which shall be so certified shall thereupon be paid by the Owner to the Contractor or by the Contractor to the Owner, as the case may be, and the certificate of the Architect shall be final and conclusive between the parties.

27. If at any time after the commencement of the work the Owner shall for any reason whatsoever not require the whole thereof, as specified in the tender, to be carried out, but need to abridge the Contract, the Owner shall give notice in writing of the fact to the Contractor who shall have no claim to any payment or compensation which he might have derived from the execution of the work in full, but which he did not derive in consequence of the whole amount of the work not having been carried out. The Contractor shall in this case, however, be entitled to payment for the work already executed by him in accordance with the agreed rates. The Owner shall also take over all building materials as might have been ordered for the work, but orders for which cannot be canceled, if delivered within a reasonable time, and shall pay for them at cost price. The Contractor shall also be allowed to remove his tools and plants from the site.

#### **28. Termination of Contract by Contractor**

- a) If payment of the amount payable by the Owner under Certificate of the Architect /PMC for beyond two months from date of issue of certificate due to reason not attributable to the contractor.
- b) The Owner commits any 'Act of Insolvency', or
- c) If the Owner (being an individual, or firm) shall be adjudged an Insolvent, or (being an Incorporated Company or Society) shall have an order made against him or pass an effective resolution for winding up, either compulsorily or subject to the supervision of the Court or voluntarily, or if the Official Assignee or the Owner shall repudiate the contract, or if the Official Assignee or the Liquidator in any such winding up shall be unable within fifteen days after notice to him requiring him so to do, to show to the reasonable satisfaction of the Contractor that he is able to carry out and fulfill the Contract and to make all payments due, and to become due there under and, if required by the Contractor, to give security of the same, or
- d) If the works be stopped for three months or more under a continuous spell under the order of the Architect /PMC or the Owner or by any injunction or other order of any Court of Law, Then and in any of the above said (Clause 28) cases the Contractor shall be at liberty to determine the Contract by notice in writing to the Owner, through the Architect, and he shall be entitled to recover from the Owner payment for all works executed and cost of the material supplied and lying at site for the purpose of the Contract as on the said day of the termination. No other claim for idle labour, loss of overheads, profits shall be entertained nor shall any other claim on account of the delay in completion of the work /availability of site/ unwarranted conditions whatsoever shall be tenable, even if it is caused by circumstances beyond the Contractor's control.

#### **29. Procedure for Settlement of Disputes**

##### **29.1 Engineer's Decision**

If a dispute of any kind whatsoever arises between IIIT-Delhi and the contractor in connection with, or arising out of, the contract or the execution of the works, whether during the execution of the works or after their completion and whether before or after any repudiation or other termination of the contract, including any dispute as to any opinion, instruction, determination, certificate or valuation of the engineer, the matter in dispute shall, in the first place, be referred in writing to the engineer, with a copy to all parties. Such reference shall be made within one (1) month of arising of any such dispute and state that it is made pursuant to this clause. No later than one (1) month after the day on which he received such reference the engineer shall give notice of his decision to IIIT-Delhi and the contractor. Such decision shall state that it is made pursuant to the reference under this clause.

Unless the contract has already been repudiated or terminated, the contractor shall in every case, continue to proceed with the works with all due diligence and the contractor and IIIT-Delhi shall give effect forthwith to any / every such decision of the engineer unless and until the same shall be revised, as hereinafter provided, in an amicable settlement or an arbitral award. If either IIIT-Delhi or the contractor be dissatisfied with any decision of the engineer, or if the engineer fails to give notice of his decision on or before one (1) month after the day on which he received the reference, then either IIIT-Delhi or the contractor may within a further period of one (1) month from the day on which it / they receive(s) the notice of such decision, or on the day on which the said period of notice of / for decision expired, as the case may be, give notice to the other party, with copy for information to the engineer, of its / their intention to commence arbitration. Such

notice shall establish the entitlement of the party giving the same to commence arbitration, as hereinafter provided, as to such dispute and no arbitration in respect thereof may be commenced unless such notice is given. If the engineer has given notice of his decision as to a matter in dispute to IIIT-Delhi and the contractor and no notification of intention to commence arbitration as to such dispute has been given by either IIIT-Delhi or the contractor as herein provided, the said decision shall become final and binding upon IIIT-Delhi and the contractor.

**29.2. Amicable Settlement**

Where notice of intention to commence arbitration as to a dispute has been given in accordance with sub-clause 22.1, arbitration of such dispute shall not be commenced unless an attempt has first been made by the parties to settle such dispute amicably. Provided that, unless the parties otherwise agree, arbitration may be commenced on or after one (1) month from the day on which notice of intention to commence arbitration of such dispute was given, whether or not any attempt at amicable settlement thereof has been made or result achieved.

**29.3. Arbitration:** Any dispute in respect of which:

a) the decision, if any, of the engineer has not become final and binding pursuant to the first sub-clause above,

b) amicable settlement has not been reached within the period stated in the second sub-clause above, shall be finally settled, unless otherwise specified in the contract, by arbitration to be held in New Delhi in English, under the provisions of the Arbitration and Conciliation Act 1996, including any statutory reenactment(s) / amendment(s) thereof and Rules made thereunder, by the arbitrator. The Director of the Institute shall appoint one person as the sole arbitrator. Either party shall be limited in the proceeding before such arbitrator to evidence or arguments put before the engineer for the purposes of obtaining the said decision pursuant to the first sub-clause herein. No such decision shall disqualify the engineer from being called as a witness and giving evidence before the arbitrator on any matter whatsoever relevant to the dispute. Arbitration proceedings shall not be commenced prior to the completion of the works, unless any major pre-requisite criticality is discerned by the arbitrator, and the obligations of IIIT-Delhi, the engineer and the contractor shall not be altered by reason of the arbitration. The works shall not be stopped on account of the said process of arbitration and the contractor shall not be relieved of his responsibilities for the completion of the work under any circumstances whatsoever.

**30. Contractor to provide everything necessary**

The Contractor shall provide everything necessary for the proper execution of the Work according to the intent and meaning of the Drawings, Schedule of Quantities and Specifications taken together whether the same may or may not be particularly shown or described therein provided that the same can reasonably be inferred there from, and if the Contractor finds any discrepancy in the Drawings or between the Drawings, Schedule of Quantities and Specification he shall immediately and in writing refer the same to the Architect who shall decide which is to be followed.

**31. Materials and Workmanship to conform to Descriptions**

All materials and workmanship shall so far as procurable be of the respective kinds described in the Schedule of Quantities and/or Specification and in accordance with the Architect's Instructions, and the Contractor shall upon the request of the Architect furnish him with all invoices, accounts, receipts and other vouchers to prove that the materials comply therewith. The Contractor shall at his own cost arrange for and/or carry out any test of any materials which the Architect may require.

**32. Assignment and Sub-letting**

The whole of the works included in the Contract shall be executed by the Contractor and the Contractor shall not directly or indirectly transfer, assign or underlet the Contract or any part share thereof or interest therein without the written consent of the Architect, and no undertaking shall relieve the Contractor from the full and entire responsibility of the Contract or from active superintendence of the Work during its progress.

**33. Removal of improper work**

The Architect shall, during the progress of the Work, have the power to order the removal, from the Site or works within such reasonable time or times as may be specified in the order, of any materials which in the opinion of the Architect are not in accordance with the Specification or the Instructions of the Architect, the

substitution of proper materials, and the removal and proper re-execution of any works executed with materials or workmanship not in accordance with the Drawings, Specifications or Instructions and the Contractor shall forthwith carry out such order at his own cost. In case of default on the part of the Contractor to carry out such order, the Owner shall have the power to employ and pay other persons to carry out the same, and all expenses consumed thereon or incidental thereto as certified by the Architect shall be borne by the Contractor, or may be deducted by the Owner from any moneys due or that may become due to the Contractor.

## ADDITIONAL CONDITIONS

1. General conditions of contract for Central PWD Works 7/8 (Tender of Form) shall be part of the agreement.
2. The work shall be carried out strictly as per CPWD specifications 2007, Part I & II with up to date correction slips. Wherever no specification is available in the above said document, drawings and specifications supplied with bill of quantities shall be applicable
3. The Contractor shall have to clear the site for the work of all overlying rubbish /garbage/dumped refuse material prior to commencement of the work in case required at no extra cost. The contractor shall take approval from the Engineer /Officer in Charge in writing for collection and stacking of materials.
4. The contractor must follow CPWD Safety Code as provided in general conditions of contract for CPWD Works.
5. Any damage done by the contractor or his workmen to any existing work during the course of execution of the work shall be made good by him at his own cost.
6. Contractor shall clear the site thoroughly of all rubbish etc. left out of his materials immediately on completion of the work and properly keep the site clean around the building to the satisfaction of the Engineer- in-Charge.
7. The preference of the codes will be IS codes.
8. The rates are inclusive of all staging, material and labour as required for the works. The items in the bill of quantities include all the materials, labour, and installation, complete as a finish items unless otherwise stated.
9. Unless specifically mentioned otherwise, quoted Rates shall be deemed to include work to be carried out at all curvatures, heights, depths, inclinations and locations, and in wet/foul locations, as and when they are encountered. The rates quoted for the various works as specified in the Priced Schedule of Quantities are work in all types of soils/rock and prevailing Site conditions including earth work, excavation, shoring, execution of various other items of work, i.e., laying of pipes, joining, concreting, masonry, plastering, etc. in and under water and dewatering as required. Nothing extra is payable on this account.
10. All security precautions shall be taken during dismantling work. The site shall be fenced /barricaded with suitable material during construction period .No payment shall be made for fencing/barricading work. Fencing/barricading shall be done immediately after possession of site and shall be removed after completion of construction period
11. No space on site/otherwise for labour huts shall be provided by IIITD, cost of same shall be borne by contractor.
12. The general condition of contract for Central P.W.D. Works has reference of various laws /acts /rules. The settlement of any disputes and arbitration, only Indian arbitration and conciliation act 1996 shall be applicable.
13. In case any specific brand of material has been specified either the same brand or of approved make of same specifications shall be used. The contractor shall take approval in advance for all such materials.
14. Costs for all materials and labour for the preparation of samples, market research, etc. shall be borne by the Contractor within his quoted Rates and nothing extra shall be payable for this. The works shall not be proceeded with without approval of the sample. In case sample is rejected and works cannot be proceeded with the IIITD shall be at liberty to terminate the contract and the Contractor shall have no claim for the works under such circumstances whatsoever.

15. The contractor should take utmost care to avoid any damage to the existing flooring, electrical works/cables, telephone cables, false ceiling, sprinkler system, fire alarm etc. in place. In case of any damage, it would be the responsibility of the contractor to restore the same immediately.

CORRIGENDUM TO FORM 7/ 8 / 9 (CPWD) MUST BE READ ALONG WITH THE PAMPHLET

S.No	FOR	READ
1	Government of India/Owner	IIITD Innovation & Incubation Center
2	C.P.W.D. or Government or Department	IIITD Innovation & Incubation Center
3	CPWD -7/8/9	CPWD 7/8/9
4	President / President of India	Chairman, IIITD Innovation & Incubation Center
5	Chief-Engineer	CEO, IIITD Innovation & Incubation Center
6	Superintending Engineer	Engineer-in-Charge
9	Administration Head	CEO, IIITD Innovation & Incubation Center
11	CPWD Code, Paragraph '90	Shall be applicable to IIIC works
12	DSR'2007	Shall be applicable to IIIC works
13	CPWD specifications 2007 part - I& II	Shall be applicable to IIIC works
14	DSR (Internal) 2007 for Electrical works	Shall be applicable to IIIC works
15	CPWD specifications (Internal) 2007 for Electrical works	Shall be applicable to IIIC works
16	DSR External 2007 for Electrical works and specifications	Shall be applicable to IIIC works
17	Provision of Section 12 Sub-Section (i) of the works man compensation	Shall be applicable to IIIC works
18	CPWD safety Code framed from time to time	Shall be applicable to IIIC works
19	CPWD maternity benefits to labour	Shall be applicable to IIIC works
20	Model Rules of the protection of health and sanitary appointment for workers employed by CPWD	Shall be applicable to IIIC works
21	CPWD contractor labour Regulations	Shall be applicable to IIIC works

## SPECIFICATIONS

### 1. GENERAL

- 1.1. Without forgoing the requirements of the conditions of Tender and the Conditions of Contract the works in general shall conform to the "Specifications 2007" published by CPWD, New Delhi and the "Specifications for works" stated in this tender. In case items not covered by the general specifications referred above, reference shall be made to the appropriate I.S. Codes. If there is any difference in the particular specifications of individual item of work and the description of item as given in the Schedule of quantity, the latter shall prevail. In case of any work for which there is no specification in I.S. specifications in the specifications forming part of tender documents or in case there is any variation, such work shall be carried out in all respects in accordance with the instructions to be issued by the Engineer-in-charge. The term Officer in Charge appearing in the specifications shall mean supervisor and be in Charge of the work or his authorized representative as the context may demand. All corrections to "Specifications 2007" or latest revisions of I.S. Code/ Specification shall be deemed to apply to this contract.
- 1.1.1. Materials bearing ISI certification mark certification shall be given highest preference for use in the works. Where the Contractor is required to do, perform, execute (etc.) any work or service or the like, it shall be deemed to be at his own cost. Absence of terms providing, Supplying, installing, fixing, etc. shall not even remotely entitle the Contractor to any additional payment there for
- 1.1.2. The rates accepted in the Schedule of Quantities apply to all floors, heights, depths, leads, lifts, spans, sizes, shapes, locations, etc. unless a distinction has been included in the very Schedule.
- 1.1.3. The Specifications and the Schedules may have been divided into various sub-heads for convenience only. This does not limit applicability of one to the other nor does it absolve the Contractor of his responsibility to complete any trade / item of work as reasonably inferred from one or more of such sub-heads.
- 1.1.4. The Schedule of Quantities is not necessarily based on "Schedule of Rates - Delhi 2007 or any of its later/ earlier versions. Hence the Schedule of Quantities shall be read and construed according to explanations given herein and intentions gathered there from. A mere parallel drawn from the said Schedule of Rates shall therefore not form a basis for a variation and, or additional payment.
- 1.1.5. All work under this contract is deemed to be performed above subs soil water level. However, removal of water collected from rains and the like shall be treated as part of contractual risk/obligation.
- 1.1.6. Screws, bolts, nuts, washers, hold fasts, lugs, anchors, clamps, plugs, suspenders, brackets, straps and fasteners of the like are deemed to be included in the rates of various items unless the Schedule of Quantities expressed a different intention.
- 1.1.7. Resetting any displacements, making good holes/chases and such other incidental jobs are included in rates of respective items for which these are required.

### 2. DRAWINGS, SPECIFICATIONS, INTERPRETATIONS ETC.

In general, drawings shall indicate the dimensions, positions and type of construction, the specifications shall stipulate the qualities and the methods and performance criteria, and the schedule of quantities shall indicate the provisional quantities and the rates for each item of work. However, the above documents being complementary, what is called for by any one shall be as binding as if called for by all. In case of contradictory requirements between specifications and schedule of quantities, the requirements given in the schedule of quantities shall prevail.

Special conditions being mainly an amplification of General Conditions, they shall be read in conjunction with each other.

Work indicated on the drawings and not mentioned in the schedule of quantities or specifications or vice versa, shall be deemed as though fully set forth in each. Work not specifically detailed, called for, marked or specified, shall be the same as similar parts that are detailed, marked or specified.

**Special Note**

**Though every care is taken while preparing this document to cover all necessary matters, specifications, general conditions, special conditions, provisions for smooth and complete execution of work, however in case of any omission in the tender/ contract document, latest correction slips of general conditions of contract for CPWD Works 2014 will be the reference manual but not in supersession to aforesaid conditions.**

**LIST OF APPROVED MAKES**

Note: Equivalent makes shall be considered only on non-availability of approved specified makes. In general no change in brand will be entertained, however, the executing agency / vendor having similar experience will be / can be considered in case of non-availability of any from the BOQ make list.

**HVAC System design**

1. A set point temperature of 26° ±1 in summer and 20° ±1 in winter should be maintained in proposed Incubation Centre.
2. All the HVAC equipment should have capability to deliver heating and cooling functions/operations for all types of units : Cassette/ FCU /Splits/CSU etc.
3. Thermostat, fan and valve control wiring to be provided from for each of the units by the vendor. This is for enabling connections to the Wi-Fi enabled BMS system that will be supplied by IIITD Innovation & Incubation Centre (IIIC)

**AGREEMENT**

AN AGREEMENT is made this -----BETWEEN the CEO for and on behalf of IIITD Innovation & Incubation Centre (IIIC), a section (8) company promoted by IIIT Delhi, Okhla Industrial Area, Phase III, New Delhi 110020 ,and with its registered office at Okhla Phase III , New Delhi 110020,

WHEREAS the Authority has, under tender Notification No. -----

---

-----.  
WHEREAS the contractor has submitted tender for carrying out the work as above as per the tender document page ---- to ---- and has represented that in conformity with his / its obligation contained in the tender as modified by the correction slips and corrigendum contained he / it shall carryout the same truly, faithfully and honestly.

THE SAME has been accepted by both the parties on the terms and conditions, corrections, corrigendum contained in the tender as modified as well as the letter of acceptance Issued party No.1 annexed here to as.

The same shall be binding on both the parties.

IN WITNESS WHEREOF, the parties have signed the deed of agreement on the date, month and year referred to above.

Date: -----  
At New Delhi.

Signed by \_\_\_\_\_

Party No.1

Party No.2

---

WITNESS

1. ----- Party No.1
  
2. ----- Party No.2



## SPECIFICATIONS

### I FAN COIL UNITS & HYDRONIC CASSETTE UNITS

#### 1. FAN COIL UNITS

##### 1.1 SCOPE

The Scope of this section comprises the supply, erection, testing and commissioning of Fan Coil units conforming to these Specifications and in accordance with requirements and drawings.

##### 1.2 TYPE

The fan coil units shall be horizontal type for ceiling suspension. All units shall be complete with chilled water coil of three rows deep, direct driven (three speed) centrifugal fans and motor, cleanable filters sandwiched insulated condensate drain pan as detailed in item drain pan, and **20** gauge pre coated GI casing panels insulated on discharge side of the fan.

##### 1.3 CAPACITY

The air moving and coil capacities shall be as per scheduled B.O.Q.

##### 1.4 CABINET

Cabinets shall be constructed of 20 gauge Pre coated GI sheet steel. Corners shall be rounded without break lines. The cabinets shall be of sufficient size to enclose all piping and control valves, and shall have access doors to piping and controls. Access panels shall have positive locking fasteners for easy removal.

##### 1.5 INTERIOR CHASSIS

The interior chassis shall be constructed of not less than 16 gauge GI sheet and all cold panel surfaces shall be covered with sandwiched insulation of not less than 13 mm thick PUF insulation. All fan coil units shall be securely mounted from the building structure and shall be set dead level in both directions.

##### 1.6 DRAIN PAN

The drip trays are manufactured from Stainless Steel sheet 304 grade , The pans shall be insulated with not less than 13 mm thick PUF insulation sandwiched between top and bottom panels to effectively prevent condensation. And drain is provided with a 20 mm O/D threaded pipe.

An extension condensate pan similar to primary drain pan shall be provided by the manufacturer on those units where coil connections are to be made on both ends of the coil.

##### 1.7 COOLING COIL

All coils shall be of **staggered seamless copper tube** with aluminium plate fins mechanically bonded to copper tubes. Number of the row for cooling coils shall be as called for in the schedule of quantities. Tubes shall be minimum 9.5 mm OD and wall thickness shall be minimum 30 G. Each coil shall be provided with an air vent and drain plug. All coils shall be factory tested at 21Kg. per Sq.cm (300 psig) air pressure while submerged in water. Fin spacing shall be 11 or 13 fins per inch. Tubes shall be Mechanically / Hydraulically expanded for minimum thermal contact resistance with fins.

##### 1.8 FANS

Fans shall be centrifugal, forward curve, direct driven by a permanent split capacitor motor equipped with built-in overload protection.

**1.9 MOTOR**

The permanent split capacitor motors are of the PSC 3-speed type, six pole and equipped with built-in overload protection Single phase 230 V / 50 Hz and shall be factory wired to a junction box.

**1.10 ISOLATORS**

Ceiling-suspended horizontal units mounted within the ceiling space shall be hung through neoprene in shear type vibration isolation suspensions, placed between the suspender rods of required sizes.

**1.11 ACCESSORIES**

All fan coil units shall be provided with the following accessories as detailed item-wise in the schedule of quantities:

Wall mounted thermostat for individual unit, containing three-speed and on-off control for fan speed, temperature control for summer/winter system (price separately)

Set of Ball Valves (with & without strainer) and PID valves in water lines for individual unit for each coil connection (price separately)

Fireproof double layer canvass connection.

Flexible copper piping for each coil connection.

**1.12 FILTERS**

The filters shall be made out of synthetic mesh woven box type. The filters frame work shall be out of Galvanized/Aluminium channels. Thickness of filter shall be minimum 12 mm.

**1.13 PAINTING**

Powder coating that have become marred during shipment or erection shall be cleaned off with mineral spirits, wire brushed and spot primed over the affected areas, then coated with enamel paint to match the finish over the adjoining surfaces.

**1.14 NOISE CONTROL**

Fan coil units shall be selected for the lowest operating noise level of the equipment. Fan performance rating, power consumption and sound power data with operating points clearly indicated shall be submitted by the tenderer during submission of technical submittals for approval and verified at the time of testing and commissioning of the installation.

**1.15 TESTING**

Cooling capacity of various fan coil units shall be computed from the measurements of air flow and dry and wet bulb temperatures of air entering and leaving the coil. Flow measurements shall be by a anemometer and temperature measurements by accurately calibrated mercury-in-glass thermometers. Computed ratings shall conform to the specified capacities and quoted ratings Noise level at various locations within the conditioned spaces shall be measured by a sound pressure level meter.

**2. CASSETTE CHILLED WATER UNIT**

**2.1 SCOPE**

The Scope of this section comprises the supply, erection, testing and commissioning of chilled water cassette units conforming to these Specifications and in accordance with requirements and drawings.

**2.2 TYPE**

The chilled water cassette units shall be ceiling suspension type. All units shall be complete with chilled water coil direct driven aerodynamic design diffuser fan and motor, cleanable filters, in built drain pump for drain units shall have U-slots in top panels for ease of installation. .

**2.3 CAPACITY**

The air moving and coil capacities shall be as scheduled B.O.Q.

**2.4 CABINET**

The housing shall be of galvanized steel. The body shall be light in weight and shall be able to suspend from four corners. The cabinet shall be as per manufacturer standard.

**2.5 COOLING COIL**

All coils shall be of **staggered seamless copper tube** with aluminium plate fins mechanically bonded to copper tubes. Tubes shall be minimum 9.5 mm OD and wall thickness shall be minimum 30 G. Each coil shall be provided with an air vent and drain plug. All coils shall be factory tested at 21Kg. per Sq.cm (300 psig) air pressure while submerged in water. Fin spacing shall be 12 or 13 fins per inch. Tubes shall be Mechanically / Hydraulically expanded for minimum thermal contact resistance with fins.

**2.6 FANS**

Fans shall be multi- blade centrifugal & direct driven by a permanent split capacitor motor.

**2.7 MOTOR**

The permanent split capacitor motor are of the PSC 3 – speed type, six pole, single phase, 230 Volt, 50 Hz. and Speed not exceeding 1050 RPM at maximum air flow. Motors shall have three speed windings and shall be factory-wired to a junction box.

**2.8 ISOLATORS**

Ceiling-suspended horizontal units mounted within the ceiling space shall be hung through neoprene in shear type vibration isolation suspensions, placed between the suspender rods of required sizes.

**2.9 ACCESSORIES**

All fan coil units shall be provided with the following accessories as detailed item-wise in the schedule of quantities:

Wall mounted thermostat for individual unit, containing three-speed and on-off control for fan speed, temperature control for summer/winter system (price separately)

Set of Ball Valves (with & without strainer) and PID valves in water lines for individual unit for each coil connection (price separately)

Flexible copper piping for each coil connection.

**2.10 FILTERS**

The filters shall be made out of fine mesh air filters.

**2.11 PAINTING**

Powder coating that have become marred during shipment or erection shall be cleaned off with mineral spirits, wire brushed and spot primed over the affected areas, then coated with enamel paint to match the finish over the adjoining surfaces.

**2.12 NOISE CONTROL**

Units shall be selected for the lowest operating noise level of the equipment. Fan performance rating, power consumption and sound power data with operating points clearly indicated shall be submitted with the tenders and verified at the time of testing and commissioning of the installation.

2.13 **TESTING**

Cooling capacity of various fan coil units shall be computed from the measurements of air flow and dry and wet bulb temperatures of air entering and leaving the coil. Flow measurements shall be by a anemometer and temperature measurements by accurately calibrated mercury-in-glass thermometers. Computed ratings shall conform to the specified capacities and quoted ratings Noise level at various locations within the conditioned spaces shall be measured by a sound pressure level meter.

\*\*\*\*\*

## **II INLINE/AXIAL/PROPELLER FAN**

### **1. SCOPE**

The Scope of this section comprises supplying, storing, erection, testing and commissioning of Inline Fan, Axial Fan & Propeller Fan conforming to these Specifications and in accordance with requirements of schedule of quantities.

### **2.0. INLINE FAN/AXIAL FANS**

#### **2.1 INLINE FAN**

1. The Inline fans shall be cabinet/circular type meeting the site requirement and as per manufacturer standard specification.
  - i) Housing shall be constructed of strong galvanized steel in riveted construction.
  - i) Fan Wheel shall be backward/forward curved type, Fan Wheel shall be statically and dynamically balanced.
  - ii) Shaft shall be constructed of steel.
  - iii) Bearings shall be of the ball-bearing type mounted on the fan housing. Bearings shall be designed especially for quiet operation and shall be of the self-aligning, self lubrication type.
  - iv) Motor shall be suitable for 230 volts, 50 cycles, 1 phase power supply direct driven centrifugal impeller, SPDP/TEFC Squirrel Cage induction motor. Motor name plate horsepower shall exceed brake horsepower by minimum of 10%. Motor shall be designed specially for quiet operation and motor speed shall be as per manufacturer standard.
  - v) Drive to fan shall be direct driven.
  - vi) All accessories required for proper installation and commissioning.

#### **2.2 AXIAL FLOW FAN**

- i) The fans shall be of the direct driven axial type with cast aluminum airfoil propellers.
- ii) The casing shall be constructed of continuously welded steel and include integral punched inlet and outlet flanges to prevent air leakage. The casing and motor base shall be constructed from precision laser cut and formed members of heavy gauge steel to prevent vibration and rigidly support the motor. Motor support brackets shall be welded to fan casing for increased strength.
- iii) Motor shall be suitable for operation on  $415 \pm 10\%$  Volt, 50 Hz, AC supply with EFF-1 ratings & "H" class insulation.
- iv) Blades shall be airfoil design. Hub and blades shall be a high strength cast aluminum alloy. Blade pitch shall be manually adjustable with out removing from the fan casing. Rotors shall be statically and dynamically balanced. A tapered lock bushing shall be used to mount the propeller to the motor shaft.
- v) All the Steel casings and structural components shall be coated with Permator, an electrostatically/as per standard applied thermosetting polyester urethane.
- vi) Fan performance shall be based on tests conducted in accordance to AMCA 210 (meets BS848 part 1), licensed to bear the AMCA Air and noise label in accordance with AMCA Publication 211 and comply with the requirements of the AMCA Certified Ratings Program.

- vii) The motor assembly shall be fire rated for high temperature application (250 °C for minimum of 2 hours).
- viii) All required accessories as required as per site requirement.

### 2.3 PROPELLER FAN

- i) Propeller fans shall be direct – driven, three or four blade type, mounted on a steel mounting plate with orifice ring.
- ii) Mounting plate shall be of heavy gauge sheet steel construction, streamlined venturi inlet (reversed) for supply applications. The mounting plate size shall suit the fan size.
- iii) Fan blades shall be constructed of aluminium or steel. Fan hub shall be of heavy welded steel construction with blades bolted to the hub. Fan blades and hub assembly shall be statically and dynamically balanced at the factory.
- iv) Motor shall be standard (easily replaceable) single phase, permanent split capacitor or shaded pole for small sizes, totally enclosed with pre – lubricated sleeves or ball bearings, designed for quiet operation. Motor for larger fan shall be suitable for  $415 \pm 10\%$  volts, 50 cycles, 3 phase, power supply. Motors shall be suitable for either horizontal or vertical services.
- v) All required accessories as required as per site requirement.

### 2.4 INSTALLATION

- i) The Contactor shall supply all required bolts, base frame(whenever (wherever required), vibration isolators any other accessories and shall assure that the components are placed securely in proper position.
- ii) Vibration isolators shall be provided with an efficiency of not less than 80%.

### 2.5 TESTING

All the fans shall be tested for performance at the factory and the following test results shall be furnished.

- i) C F M
- ii) Static pressure at the specified flow rate
- iii) KW input to motor

\*\*\*\*\*

## II VALVES & FITTINGS

### 1. SCOPE

The scope of this section comprises the supply, laying, erection, testing and commissioning of pipes required for this project as per drawings.

### 2. BUTTERFLY VALVES

- |                                     |                 |
|-------------------------------------|-----------------|
| a) size up to 150 mm dia (PN 16)    | Handle Operated |
| b) size 200 mm dia and above (PN16) | Gear Operated   |

### 3. TWO WAY MOTORIZED BUTTERFLY VALVE

#### 3.1 Valve

- |                                   |   |                         |
|-----------------------------------|---|-------------------------|
| a. Type of valve                  | : | Butterfly Valve.        |
| b. Body Material                  | : | Carbon steel ASTM A 216 |
| c. Body seat ring (if applicable) | : | Gr WCB                  |
| d. Vane                           | : | SS-316                  |
| e. Packing                        | : | Teflon                  |
| f. Mounting Stool                 | : | Required.               |
| g. Shaft                          | : | SS-316                  |
| h. Seat                           | : | Nitrile rubber          |
| J Fasteners                       | : | SS-316                  |

#### 3.2 Actuators

- |                        |   |  |
|------------------------|---|--|
| Type                   | : | Electric                               |
| Duty.                  | : | On/Off (Maximum 50 operations per day) |
| Motor power supply     | : | 230 V AC or 415 V 3-phase              |
| Travel limit switches  | : | 2 Nos                                  |
| Torque limit switches. | : | 2 Nos                                  |
| Hand wheel             | : | Required                               |
| Speed                  | : | Approx 150 mm/min                      |

#### NOTE:-

- a. Actuator must open/ close with one changeover contact. Control panel, if required, must be supplied integral with the Actuator.
- b. No gear box is envisaged, however if gear box is provided, the travel limit switches must be connected directly to the valve stem.
- c. Cover tube for the valve stem must be provided

### 4. POT STRAINERS

Strainers shall be of approved type with fabricated steel bodies designed to the test pressures specified for the valves. Strainers shall have removable stainless steel screen with 1.5 mm perforations and a permanent magnet. Strainers shall be provided with flanges as required. They shall be designed so as to enable blowing out accumulated dirt and facilitate removal and replacement of screen without disconnection of the main pipe. All strainers shall be provided with equal size isolating valves and by-pass line so that the strainer may be cleaned without draining the system. Strainers shall be provided on the suction header of the pumps wherever shown in the drawings. The velocity across the filter mesh should not exceed one fifth of the velocity in the connecting pipe. The area of the filter mesh shall be five times of the area of the pipe connection.

### 5. EXPANSION TANK & AIR SEPARATOR

**5.1 EXPANSION TANK**

The chilled water system shall be provided with pre-charged steel expansion tank in the plant room as shown on the drawings. The tank should be designed to absorb the expansion forces of the chilled water system while maintaining proper system pressure under varying operating system conditions. The shell of the tank shall be constructed out of carbon steel conforming to section 8, of ASME boiler & pressure vessel code. The vessel shall be designed for maximum design pressure of 150 psig. The tank shall be painted with one shop coat of dry enamel paint. The tank shall be provided with two 1 inch tappings in the shell for safety relief and system connection. The tank shall also have suitable size drain connection. The tank shall have replaceable type, butyl – rubber bladder. The tank shall be pre-fitted with lifting rings & shall have suitable mounting arrangement. Expansion Tank shall be with pressurization unit complete with pressure gauges, transmitter, valves etc. including 2 pump sets (1 working 1 standby) whole assembly shall be from one source, pump rating shall be as per manufacturer standard and as per requirement.

**5.2 AIR SEPARATOR**

The air separator shall be constructed out of steel suitable for a maximum pressure of 150 psig at maximum Operated Temperature 350<sup>o</sup>F / 177<sup>o</sup>C. The tank shall be complete with air separation fittings, air venting arrangement, strainer with equally sized Ball type isolation valve, pressure reducing valves, isolation valves, quick fill connection, inlet & outlet flanges. The air separation efficiency shall be more than 96-98 %. The model shall be got approved from the engineer-in-charge before placement of order.

Air separator shall be insulated as per specifications given under head of “Insulation”.

\*\*\*\*\*



#### **IV CONTROLS AND INSTRUMENTS**

**1. SCOPE**

The scope of this section comprises the supply, erection, testing and commissioning of automatic controls and instruments conforming to these specifications and in accordance with the requirements of Drawings and Schedule of Quantities.

**2. TYPE**

All automatic controls shall be of approved as described in the various sections of these specifications.

**3. AUTOMATIC CONTROLS**

Automatic controls required for various types of equipment/machines have been described in the various sections of these specifications. The individual safety controls and various automatic controls shall be installed within the equipment/machines by the manufacturers before shipment. However, the following automatic controls, if not already installed on the equipment/machines, may need to be installed at site by the Contractor, as per the Schedule of Quantities.

**4. 2 WAY MODULATING / PRESSURE INDEPENDENT BALANCING AND CONTROL VALVE**

HVAC APPLICATION- COOLING & HEATING - AHU's, FCU's & Cassettes

A pressure independent balancing and control valve shall be a self balancing, pressure independent, 2-way control valve with 100% authority on the control valve. It can be fitted with an actuator to accept input signals from the control system.

Each Air Handling Unit / Fan Coil Unit / Cassette Unit shall be provided with a 2-way Pressure Independent Balancing and Control Valve. The control valve should be a globe type.

Regarding control – The response characteristic should be independent of pressure, A differential pressure controller should ensure 100% valve authority at all loads and all settings.

Regarding Balancing – Each Valve should have a precisely adjustable maximum flow limitation as per the designed flow rate of coils. The balancing should be done only in the valve and not in the actuator so that in case of actuator failure, the balancing is not lost and the system can still function as designed.

All Valves actuators should be microprocessor based with a self calibrating feature to adjust to any valve travel or setting with full control range..

The valve should have a linear characteristic and the actuator should have a function that can convert it to a logarithmic characteristic to ensure that the valve-actuator combination can be used for all applications.

Minimum required differential pressure should not exceed 20 kPa for fan coil units DN32 and not exceed 30 kPa for air handling units to minimize pump head requirements,

The valve should be equipped with an electronic modulating actuator which can accept either 4(0)-20 mA / 2(0)-10 V DC signals. Operating voltage for actuator shall be 24V AC. The actuator shall be able to close against maximum differential pressure of 6 Bar

**VALVE SPECIFICATIONS**

Discription	For 15 to 32 mm	For 40 to 150 mm
Diff Pressure (P1-P3)	16 To 400 kPa	30 To 400 kPa
Media Temperature	-10 ° to 120 °C	-10 ° to 120 °C
Body Material	Brass (CuZn40Pb2 - CW 617N)	Grey iron EN-GJL-250(GG25)
Test Ports	Needle measuring nipple	Needle measuring nipple

Leakage acc. to standard IEC 534	No visible leakage (at 100N)	max.0,01 - 0.05% of kv at 650N
Stem Seals	EPDM - CuZn40Pb2	EPDM -NBR
Maximum Close Off Pr	600 kPa	600 kPa
Pressure rating	PN16	PN16
Control Range	Standard IEC 534 Since CV Characteristic is linear control range is Infinity (1:256 as a result of the actuator-valve combination)	
Control Valve Character	Linear characteristic and, with the help of actuator, logarithmic	

**ACTUATOR SPECIFICATIONS FOR ALL SIZES**

**Supply Voltage** : 24V AC  
**Power Consumption** : 10V AC  
**Frequency** : 50 HZ  
**Control Input** : 2-10V DC, 4-20mA, 3-point Selection.  
**Position Output** : 2-10V DC 4-20mA

**Body Housing Insulation** : Non Corrosive - IP 42 or higher

**GENERAL SPECIFICATIONS: Pressure Independent Balancing and Control Valve shall be provided/installed at each outlet of cooling coil unit, Cassette, AHU & FCU.**

**A:- Valve Body and Characteristics:-**

- The differential pressure controller should maintain a constant differential pressure across the control valve, irrespective of fluctuations in the system, with the help of a self adjusting diaphragm.
- The control valve shall accurately control the flow with help of a modulating actuator
- All valve sizes should have testing ports for verifying the flow by measuring the differential pressure.

**B:- Valve Actuator and Housing:-**

- The valve and actuator must have the ability to undertake both Logarithmic control characteristics and linear control characteristics. This ensures compatibility for both Water/Air and Water/Water Heat Exchanger.
- Control/Dip switch settings should be easy to access, to avoid Manual Contact directly with Integrated IC Circuit of the system.
- The actuator should not play a part in the balancing process. This will ensure that an operational issue in the actuator will not lead to a loss of balancing, causing problems elsewhere in the system.
- Only linear characteristics should not be acceptable as with this valve & actuator characteristic, the resultant energy characteristic will not remain linear and this shall lead to improper control leading to fluctuating room temperatures.
- In chilled water systems, the valve should be mounted with the actuator above the valve to prevent condensation water leaking into the actuator.

**C:- Valve Flow Balancing :-**

- Balancing & Control: The balancing should be accomplished by the spring loaded diaphragm and the control should be done by the actuator receiving signals from room thermostats or BMS.
- Flow Setting Balancing (Commissioning) for the valves should be simple and not require measuring devices.
- Setting the flow should not involve the actuator.
- Proper operation of the valve should not be dependent on additional operations like de-airing of the valve or flushing procedures

**5. Thermostats :**

Shall be cooling/heating electronic type with 3 point output for modulating 2 position reversible motor of two way valve of AHU/FCU/Cassette with sensing element located in the return air stream. The profile, mounting arrangements and exact location of the thermostats shall be as approved by the Engineer in charge. All thermostats shall be supplied with the standard mounting boxes, as recommended by the manufacturer.

Electronic type thermostats for cooling/heating application for actuating the two way modulating cum pressure independent balancing valve at each unit.

6. **2 WAY ON / OFF VALVE**

HVAC APPLICATION- COOLING - FCU/ Hydronic Cassette Wall

Following are specification of the same.

Valve body	-	Brass body
Spindle	-	SS
Spindle packing	-	O – ring
Shut off Ball	-	EPDM

Rate Pressure	-	25 Bar
Fluid Temperature Range	-	5 – 110 °C
Supply Voltage	-	230 V, 1 Ph, 50 Hz.
Protection	-	IP 20

**ACTUATOR (ON/OFF Type)**

Power	-	230 Volts AC, 24/48V AC /DC ± 10%
Maximum Operating	-	6 VA
Control Signal	-	2/3 point 0(2) – 10V DC
Feed Back	-	0(2) – 10V AC
Rotation	-	95°
Direction of Rotation	-	Reversible
Running Time	-	120S
Over Load	-	Automatic
Ambient	-	10 to 50°C, 90% RH

\*\*\*\*\*

## V ELECTRICAL INSTALLATION

### 1. SCOPE

**The scope of this section comprises of the fabrication, supply, erection, testing and commissioning of ELECTRICAL CONTROL PANELS, wiring and earthing for all components of the HVAC system confirming to these specifications in accordance with requirements of schedule of quantity and drawings.**

### 2. GENERAL

- i) Unless otherwise specified in the tender specifications, all equipments and materials for electrical works shall be suitable for continuous operations on 415 V / 240 V  $\pm$  10 % (3 phase / single phase), 50 Hz. AC system.
- ii) All electrical works shall be carried out in accordance with the specification, local rules, Indian electricity act 1910 as amended upto date and rule issued there wide, regulations of the local fire insurance association and Indian standard code of practice IS – 732 including Indian electricity Rules, 1956 as amended to date.
- iii) All parts of electrical works shall be carried out as per appropriate CPWD General specifications for Electrical works, namely, Part I (Internal) 2005, Part II (External) 1994 work, and Part IV (Sub – Station), 2007 all as amended to date.
- iv) All materials and components used shall conform to the relevant IS specifications amended to date.

### 3. WIRING SYSTEM

All power wiring shall be carried out with 650/1100 Volts grade PVC insulated aluminium conductor armoured cable, sized for starting current and continuous running current carrying capacity and by applying proper de-rating factor. Termination of conductors shall be by means of crimping. No joints shall be permitted.

### 4. CONTROL PANELS

#### 4.1 M.V. PANELS

All the M.V. panels shall be suitable for operation on 3 phase, 415 Volts, 50 Cycles, neutral grounded at transformer and short circuit level not less than 35 MVA at 415 Volts.

The M.V. panels shall comply with the latest edition of relevant Indian Standards and Indian Electricity rules and regulations.

#### 4.2. CONSTRUCTION FEATURES

The M.V. Panels shall be metal enclosed sheet steel cubicle, indoor, dead front and floor mounting type and shall be fabricated as described in Package A of this tender.

The M.V. panel shall be of adequate size with a provision of 20% spare space to accommodate possible future additional switch gear.

Defeat interlocks shall be provided for isolating devices as specified keeping safety in mind. Mechanical and Electrical inter locking shall be provided as specified.

The power and control circuits shall have self aligning and self isolating contacts. The fixed and moving contacts shall be easily approachable for maintenance/replacement.

In case plug and socket arrangement is used for control connection, the design should ensure that only a particular plug can be inserted in the specific socket.

Withdraw-able modules shall have 3 positions i.e. service-test-isolated. In test position the power supply shall be disconnected but the control supply shall remain connected.

The draw out module shall have a latch arrangement before full draw-out position to prevent accidental fall of the module during removal. With the draw-out module removed, the live parts exposed in the panel, shall either be finger proof or shall be shrouded to prevent contact.

#### 4.3 SWITCHGEAR & ACCESSORIES

**The specifications for switchgears, accessories & its controls, metering shall be referred to Package A of this tender.**

##### i) MOULDED CASE CIRCUIT BREAKERS (MCCB's)

MCCB shall be panel-mounted type. All the live parts of MCCB shall be enclosed in a moulded case and all contacts shall be silver-plated.

MCCB shall be trip-free with quick make and quick break operating mechanism.

The feeders for all those motors having more than or equal to 7.5 HP capacity shall be provided with fully automatic Star Delta starters with motor duty MCCBs for short circuit protection only (ICS = 100% ICU ) & Overload Relays with contactors of suitable range & ratings, for overload protection, while less than 7.5 HP motor shall have DOL starter. Single phase preventers shall be provided for all 3 phase motors. Single phase preventer shall be in conformity with relevant ISI standards. Single phase preventers shall act when the supply voltage drops down to 90 % of the rated voltage or failure of one or more phases. Single phase preventer shall be voltage operated and of approved make.

Other feeders of the panel which don't require starter, shall be housed with :

- a) MCCB with Thermal magnetic release & should provide adjustable setting for overload and short circuit protection with ICS = 100% ICU.
- b) MCB used for controlling shall be with tripping characteristics of C curve. The miniature circuit breakers shall be 1/2/3/4 pole as per requirement. The breaking capacity of MCBs shall have minimum 10KA.

The protection devices of outgoing MCCB feeders shall be properly co-ordinated for tripping settings.

The fault level withstand capacity of the MCCB shall match that of the switchgear. Backup protective fuses shall not be used with MCCB for fault level compensation.

The operating handle of the MCCB shall be interlocked with the module door such that the door cannot be opened with the MCCB "ON".

The breaker handle shall indicate the operated position of the MCCB. When tripped on fault, the breaker handle shall occupy an intermediate position.

The terminals of the MCCB shall be able to accept the size of Aluminium conductor of the cables used.

The following capacity contactors and O/L relays shall be provided for different motors.

Sl. No.	Motor Cap.	Type of Starter	O/L Relay Capacity	Range
1.	7.5 HP motor	Star Delta	16 Amps	6-12 Amps
2.	10 HP motor	Star Delta	32 Amps	6-12 Amps
3.	15 HP motor	Star Delta	32 Amps	10-16 Amp
4.	20 HP motor	Star Delta	63 Amps	16-22 Amp
5.	25 HP motor	Star Delta	63 Amps	16-22 Amp
6.	30 HP motor	Star Delta	63 Amps	20-32 Amp
7.	40 HP motor	Star Delta	70 Amps	28-42 Amp
8.	50 HP motor	Star Delta	70 Amps	28-42 Amp
9.	60 HP motor	Star Delta	70 Amps	30-45 Amp
10.	75 HP motor	Star Delta	110 Amps	45-70 Amp
11.	100 HP motor	Star Delta	200 Amp	60-100 Amp
12.	150 HP motor	Star Delta	270 Amp	70-110 Amp

13. 200 HP motor	Star Delta	390 Amp	120-160 Amp
------------------	------------	---------	-------------

Single-phase preventers shall be provided for all 3-phase motors. Single-phase preventer shall be in conformity with relevant ISI standards. Single-phase preventers shall act when the supply voltage drops down to 90% of the rated voltage or failure of one or more phases. Single-phase preventer shall be voltage operated and have approved make.

Control panel shall contain starters and safety arrangements for motors of various equipment as given in schedule of quantities. It shall also house the Air circuit breaker for main incoming supply, voltmeter, ammeter with selector switch for measuring the current drawn by each motor and indicating lights for incoming phases as well as status indication of each equipment.

All control panels shall be provided with detailed control circuit diagram indicating the terminal numbers and colour coding of the wires used in the panels. This diagram shall be pasted on the inner side of the cover and protected with PVC transparent lamination.

ON-OFF switches for each motor/equipment should not be provided on the cover of the control panel, but at the same time interlocking shall be provided between switch and the door in such a way that the door of the panel cannot be opened when the supply is ON.

**4.4 POWER / CONTROL CABLING**

Contractor shall provide all power/control cables from the motor control centre to various motors, level controllers and other control devices. All power cables shall be aluminium conductor XLPE insulated, armoured and PVC sheathed. Therefore all control cables shall be of copper conductor, PVC insulated, armoured and PVC sheathed. All cables shall have stranded conductors of 1100 Volts grade. The cables shall be in drum as far as possible and bear manufacturer's name.

Specification of cable laying shall be followed as described in **Package A** of this tender, Cables and wires in conduits shall be laid on the metallic trays.

**4.5 CABLE TRAYS**

Contractor shall provide G.I perforated cable trays of sizes as given in Schedule of quantities. Detailed specification shall be followed as describe in Package A of this tender.

**4.6 EARTHING**

All three phase motor / equipments shall be earthed with two independent earth conductors as per the requirement of Indian electricity rules and regulations -1956.

Earthing specification shall be followed as describe in Package A on this tender.

**4.7 DRAWINGS**

Shop drawing for control panel and wiring of equipment showing the route of conduit/cables shall be got approved by the Engineer-in-charge before starting the fabrication of panel and starting the work. On completion two sets of completion/"As installed" drawings incorporating all details like conduit routes, number of wires in conduit, location of panels, switches, junction/pull boxes and cable route etc. shall be furnished by the contractor.

**4.8 TESTING**

Before commissioning of the equipment the entire Electrical Installation shall be tested in accordance with code of Practice IS:732-1963 (Revised) and test report furnished by a qualified and authorised person. The entire electrical installation shall be got approved by Electrical Inspector and certificate from Electrical Inspector shall be submitted. All tests shall be carried out in presence of Engineer-In-Charge..

\*\*\*\*\*

## VI HEAT RECLAIM VENTILATION /HEAT RECOVERY WHEEL

### 1. Heat Reclaim Ventilation

Supply, installation, testing & commissioning of Double skin construction cross flow heat exchanger units .Refer Equipment schedule for details.

Casing: - Double Skin wall panels, 50\_+2 mm thick Thermal insulation - CFC free injected PUF of density not less than 40 + 2 kg/cu.m. sandwiched between Outer skin shall be 0.6mm pre plasticized GSS sheet. Inner sheet shall be 0.63mm plain GSS. . Complete with Glass view panel, motor guard, marine light, limit switch, cable entry, GSS base ame, drain connection , insulated SS drain tray. Inspection door for all the sections.

Fan: DIDW Backward Curved, Centrifugal Fan with Squirrel cage induction motor, GSS frame supporting frame work, belt drive with required size pulleys and belts, spring type vibration isolators, base frame, Motor and 415±10% volts, 50 HZ Frequency,3 phase AC supply.

Filter: Each unit shall be provided with a factory assembled filter section containing washable synthetic type air filters media, class EU3 (MERV 8) mounted on Aluminium Frame. Filter bank framework shall be fully sealed and constructed from GSS. The efficiency of the filters shall be 90%down to particle size of 20 microns as per IS 7613, and ASHRAE 52.1.AHU shall be supplied with one set of pre commissioning filters

Cross flow Heat exchanger for heat Recovery application with 0.12mm thickness aluminium foil partially cross flow and counter flow suitable for indoor installation with minimum 50% efficiency. The heat exchanger must be with single folded at 3 times plate thickness 2 sides press shaping with completely sealed on the joints to leak proof construction.

Static pressure and Motor Rating : The Indicated static pressure and motor rating is only provisional. Contractor to calculate static pressure based on final approved construction drawing and pressure drop of finalized Equipment / Items and submit for review / approval to the consultants. The procurement shall be processed only after duly verification / approval of calculation and selection from the consultants.

Noise Level: Contractor to ensure noise level < 75 dBA all around the m/c.

### 2. Heat Recovery Wheel

2.1 **General:** Heat recovery wheel required for various areas shall generally be as specification given below.

2.2 **The substrate:** The substrate or wheel matrix should be only of pure aluminium foil so as to allow.

- a) Quick and efficient uptake of thermal energy.
- b) Sufficient mass for optimum heat transfer.
- c) Maximum sensible heat recovery at a relatively low rotational speed of 20 to 25 rpm.

2.3 **The Desiccant:** The desiccant should be water molecule selective and non-migratory. The desiccant should be of "Ecosorb 340" type, which combines the selectivity of a 3 A molecular sieve desiccant for the 2.8 A water molecules, and has the higher diffusivity of the 4 A molecular sieves, so as to ensure the exclusion of contaminants in the air stream, while transferring only water vapour molecules, resulting in selective and fast latent recovery.

The desiccant of sufficient mass, should be coated with non masking porous binder adhesive on the aluminium substrate so as to allow quick and easy uptake and release of water vapour. A matrix with desiccants impregnated in non metallic substrates, such as synthetic fibre, glass fibre etc. will not be accepted.

The rotor/wheel matrix shall have equal sensible and latent recovery.

The weight of desiccant coating and the mass of aluminium foil shall be in a ratio so as to ensure equal recovery of both sensible and latent heat over the operating range. Accordingly, a rotor matrix which has an etched or oxidised surface to make a desiccant on a metal foil and results in insufficient latent recovery

and hence unequal recovery, or a rotor matrix made from desiccant integrated in a synthetic fibre matrix which result in insufficient sensible recovery, high rotation speed, and unequal recovery, will not be accepted.

- 2.4 **Rotor:** With optimum heat and mass through matrix formed by desiccant, of sufficient mass, coated on an aluminium foil, the rotor should rotate at lower than 20 to 25 RPM, there by also ensuring long life of belts reduced wear and tear of seals.

The rotor shall be made of alternate flat and corrugated aluminium foil of uniform width.

The rotor honeycomb matrix foil should be so would and adhered as to make a structurally very strong and rigid media which shall not get cracked, deformed etc. due change of temperature or humidity.

The door having a diameter upto 2800 mm shall have spokes to reinforce the matrix. From 2000 mm diameter upwards, the option of a special wing structure, to prevent the rotors from wobbling or deforming due to the successive pressure differentials, will be available.

Sectioned wheels, with pie segments, capable of being assembled in the field, shall be available as an option, above 2000 mm in diameter.

The surface of the wheel/rotor should be highly polished to ensure that the vertical run out does not exceed +/- 1 mm for every 1 meter diameter, thereby ensuring, negligible leakage, if labyrinth non contact seals are provided, and minimal drag, if contact wiper deals are provided.

The radial run out also shall not exceed +/- 1 mm for every 1 meter diameter, thereby minimising the leakage/drag on the radial seals, and minimise the fluctuation in the tension of the drive belt.

The number of wraps (of alternative corrugated and flate foil) for every inch of rotor radii shall be very consistent so as to ensure uniform air flow and performance over the entire face in the air stream. Flute height and pitch will be consistent to a very tight tolerance to ensure uniform pressure drop and uniform airflow across the rotor face.

The rotor shall be a non closing aluminium media, having a multitude of narrow aluminium foil channels, thus ensuring a laminar flow, and will allow particles upto 800 microns to pass through it.

The media shall be cleanable with compressed are, or low pressure steam or light detergent, without degrading the latent recovery.

- 2.5 **The Cassette/Casing:**

Casing: - Double Skin wall panels, 50\_+2 mm thick Thermal insulation - CFC free injected PUF of density not less than 40 + 2 kg/cu.m. sandwiched between Outer skin shall be 0.6mm pre plasticized GSS sheet. Inner sheet shall be 0.63mm plain GSS. . Complete with Glass view panel, motor guard, marine light, limit switch, cable entry, GSS base ame, drain connection , insulated SS drain tray. Inspection door for all the sections.

Fan: DIDW Backward Curved, Centrifugal Fan with Squirrel cage induction motor, GSS frame supporting frame work, belt drive with required size pulleys and belts, spring type vibration isolators, base frame, Motor and 415±10% volts, 50 HZ Frequency,3 phase AC supply

The recovery wheel cassette/ casing shall be manufactured from tubular structure to provide a self supporting rigid structure, complete with access panels, purge sector, rotor, bearings, seals, drive mechanism complete with belt.

The rotor/wheel should have a field adjustable purge mechanism to provide definite separation of airflow minimising the carryover of bacteria, dust and other pollutants, from the exhaust air to the supply air. It shall be possible, with proper adjustment, to limit cross contamination to less than 0.04% of that of the exhaust air concentration.

The face and radial seals shall be four (4) pass non contact labyrinth seals for effective sealing between the two air streams, and also for a minimum wear and tear ensuring infinite life of the seals.





## SCHEDULE OF QUANTITIES

### HVAC Work for IIITD Innovation & Incubation Centre (IIC),

The prices are to be quoted in the below mentioned form and shall include the supply, installation, testing and commissioning at site of all the equipment's, ancillary materials as specified and all such items what so ever which may be required to fulfil the intent and purpose as laid down in the specification and/ or the drawings.

S.No.	Description	Unit	Qty.	Rate (Rs.)	Amount ( in Rs.)
1	<b>2 Way Motorized Valve</b>				
	Supply, installation, testing and commissioning of 2 way ON/OFF valve along with actuator & snap acting thermostat, complete as required and as per specifications of following sizes.				
	<b>(Make - Anergy/Siemens/Frease)</b>				
1.1	25 mm dia	Nos.	18		
2	<b>Cassette type Chilled Water Unit</b>				
	Supply, installation, testing and commissioning of ceiling suspended Cassette type Unit complete with casing, filter, cooling coil & multiblade centrifugal direct driven fan (three speed) with TEFC motor of class 'F' insulation, operated on 230 volts, single phase, 50Hz, AC supply, external decorative grill/panel, inbuilt drain pump, electrical & control copper cabling from nearest power point complete as required and as per specification of following capacities :				
	<b>(Make - Bhaturia/Caryaire/Carrier/Midea)</b>				
2.1	2.0 Tons , 2 row deep	Nos.	6		
2.2	1.5 Tons , 2 row deep	Nos.	2		
2.3	1.0 Tons , 2 row deep	No.	1		
3	<b>Fan Coil Unit</b>				
	Supply, installation, testing and commissioning of ceiling suspended Fan Coil Unit complete with 20 Ga G.I. precoated casing, filter box with synthetic fibre filter, 3 row dip cooling coil with Aluminium fins, direct driven fan (three speed) with TEFC motor of class 'F' insulation, operated on 230 volts, single phase, 50Hz, AC supply, sandwiched insulated drain pan power & control copper cabling from nearest power point complete as required and as per specification of following capacities :				
	<b>(Make - Bhaturia/Caryaire/Carrier/Midea)</b>				
3.1	1.5 Tons, 600 cfm	Nos.	7		
3.2	1.0 Tons, 400 cfm	Nos.	2		

4	<b><u>Insulated Chilled Water Piping (resin bonded fiberglass glass Insulation)</u></b>				
	Supplying, laying/ fixing, testing and commissioning of following nominal sizes of chilled water piping inside the building (with necessary clamps, vibration isolators and fittings but excluding valves, strainers, gauges etc.) duly insulated with 80 kg/cum density resin bonded fiber glass or 144 Kg/ m3 density mineral wool (non combustible) pipe section insulation covered with a layer of 120 gm/sq.m polythene sheet (vapour barrier) and finally applying 0.63mm aluminium sheet cladding complete with type3, grade 1 roofing felt strip(as per IS:1322 as amended up to date) at joints and repairing of damage to building etc. as per specifications and as required.				
	<b>Note:</b> The Pipes of sizes 150 mm & below shall be M.S. 'C' class as per IS : 1239 and pipes size above 150 mm shall be welded black steel pipe heavy class as per IS: 3589, from minimum 6.35 mm thick M.S. Sheet for pipes upto 350 mm dia. and from minimum 7mm thick MS sheet for pipes of 400 mm dia and above.				
	<b>(Make - Pipe - Tata/Jindal Hissar/Apollo tubes)</b>				
	<b>(Make - Insulation - U.P. Twiga/Owen Corning/K-wool)</b>				
4.1	<b><u>Piping</u></b>				
4.4.1	100 mm	RM	25		
4.1.2	80 mm	RM	40		
4.1.3	65 mm	RM	10		
4.1.4	50 mm	RM	10		
4.1.5	40 mm	RM	20		
4.1.6	32 mm	RM	5		
4.1.7	25 mm	RM	160		
4.2	<b><u>Insulated Valves</u></b>				
	Supply, installation, testing and commissioning of following valves, strainers, gauges in the chilled water plumbing duly insulated to the same specifications as the connected piping and adequately supported as per specifications.				
4.2.1	<b><u>Ball Valves</u></b>				
	<b>Ball Valve (Manual)</b> with brass body SS Ball, Nitrile Rubber Seal & O- Ring PN 16 pressure rating for chilled water/hot water circulation as specified				
	<b>(Make - Rapidcool / Emerald/CIM/Sant/Advance)</b>				
4.2.1.1	25 mm with strainer	Sets.	18		

4.2.1.2	25 mm without strainer	Sets.	18		
4.3	<b><u>Butterfly Valves</u></b>				
	BUTTERFLY VALVE (MANUAL) with C I body SS Disc, Nitrile Rubber Seal & O- Ring PN 16 pressure rating for chilled water/hot eater circulation as specified				
	<b>(Make - Advance/Honeywell/L&amp;T/)</b>				
4.3.1	100 mm dia	Set	2		
5	<b><u>Inline Fans</u></b>				
	Supply, installation, testing and commissioning of following sizes duct mounted Cabinet/ circular type inline fan complete with direct drive centrifugal impeller, TEFC squirrel cage induction motor, rubber isolator mounts and other accessories, 20 Amps SPMCB with M.S box including supply of 3 core copper flexible cable of required length & laying in existing conduit, making connections complete as required and as specified.				
	<b>(Make - Ostberg/Greenheck/Sphere/Caryaire/Airflow)</b>				
5.1	800 cfm, 15 mmwg S.P.	No.	1		
5.2	400 cfm, 10 mmwg S.P.	No.	1		
6	<b><u>Axial Flow Fan</u></b>				
	Providing, fixing, testing and commissioning of AMCA Certified (For Air and Sound Performance) vane/tube axial flow fan of capacity as mentioned below, in standard M.S./G.I. construction. Entire fan model & AMCA Seal shall appear in technical submittal of fan. All the fans are synthetic enamelled painted/hot dip galvanized with minimum 220 GSM Zinc Coating and complete with bird screen at inlet, along with backdraft damper & canvas connection at outlet. The electric motor coupler shall be squirrel cage induction motor (IE-2 type) confirming to IS - 325-IP - 55 with class 'H' insulation. Motor shall be of high temperature resistance "Class H Smoke Spill" 250° C for 2 hrs.Fan shall be CE or UL certified for high temperature. Fan Total Efficiency should not be less than 65 %, noise level should not be more than 80 dba when measured in hemispherical reverberant room conditions at a distance of 3 mtrs from the fan. Fans should be as per specification and drawings.				
	<b>(Make - Greenheck/Systemair/Airflow/Humidin)</b>				
6.1	4,000 cfm, 20 mmwg S.P.	No.	1		
7	<b><u>HRV Unit</u></b>				

	Supply, installation, testing and commissioning of heat reclaim ventilation with inlet and exhaust blower with fan (Inlet & exhaust) desiccant absorption material non contact seal, modular design with Aluminium supports of extruded section, galvanized steel plate casing, self extinguishable polyurethane foam insulation, multi-directional fibrous fleeces air filter complete as per requirements.				
	(Make - Zeco/Edgetech/Caryaire/Ostberg)				
7.1	1700 CMH / 1000 cfm, 40 mmwg.	No.	1		
8	<b><u>Drain Pipe</u></b>				
	Supplying & fixing of UPVC drain piping with all fitting such as bends, tees etc. necessary clamps, adequate support duly insulate with 9 mm nitrile rubber insulation complete as per technical specifications, requirement, standard and drawings complete as required.				
	(Make - Pipe - Supreme/Prince/Polypack)				
	(Make - Insulation - Armacell/K-flex/Aerocell)				
8.2	40 mm dia	RM	25		
8.3	32 mm dia	RM	125		
8.4	25 mm dia	RM	50		
9	<b><u>Drain Pump</u></b>				
	Providing and fixing of drain pump of suitable capacity Pump shall be designed for 3 Nos. FCUs drain capacity. Complete in all respect.	Nos.	3		
	(Make - Aspen)				
10	<b><u>G.I. Sheet Metal Ducting</u></b>				
	Supply, installation, balancing and commissioning of factory fabricated GSS sheet metal rectangular/round ducting complete with neoprene rubber gaskets, elbows, splitter dampers, vanes, hangers, supports etc. as per approved drawings and specifications of following sheet thickness complete as required.				
	(Make - Ductofab/Zeco/Ecoduct/Rollastar)				
10.1	<b><u>G.I. Sheet Metal Ducting (Rectangular)</u></b>				
10.1.1	Thickness 0.63 mm sheet	Sqm.	150		
10.1.2	Thickness 0.80 mm sheet	Sqm.	115		
11	<b><u>Grilles / Diffusers</u></b>				
	(Make - Aiflow/Servex/Caryaire/Mapro/Tristar/Systemair)				

11.1	Supply and fixing of powder coated extruded aluminium supply / exhaust air grills with aluminium volume dampers as per specifications.	Sqm	2.5		
11.2	Supply & fixing of powder coated extruded aluminium Return Air Grills with louvers but without volume control dampers complete as required.	Sqm	5.5		
11.3	Supplying, fixing testing commissioning of supply / exhaust air diffusers of powder coated aluminium with aluminium volume control dampers with anti smudge ring & removable core.	Sqm	10.5		
12	<b><u>Insulation</u></b>				
	Supplying and fixing of following thickness duly laminated aluminium foil of mat finish closed cell Nitrile rubber (Class "O") insulation on existing duct after applying suitable adhesive for Nitrile rubber. The joints shall be sealed with 50 mm wide and 3 mm thick self adhesive nitrile rubber tape insulation complete as per specifications and as required.				
	<b>(Make - Armacell/K-flex/Aerocell)</b>				
12.1	19 mm thick	Sqm	120		
13	<b><u>Louvers</u></b>				
	Supplying and installation of aluminium powder coated with louvers, bird Screen and damper as per technical specifications and drawings complete as required.	Sqm	1.0		
	<b>(Make - Aiflow/Servex/Caryaire/Mapro/Tristar/Systemair)</b>				
14	<b><u>Electric Panel Board</u></b>				
14.1	Design, manufacture, supply, installation, testing and commissioning of the MV <b>panel</b> , front operated, cubicle construction, Floor mounted type, fabricated out of 2 mm thick CRCA Sheet, Compartmentalized with hinged lockable doors, dust and vermin proof, Powder coated of approved shade after 7 tank treatment, Cable alley, inter-connections, having Switch gear and accessories mounting, internal wiring, earth terminals, Top/ Bottom cable entry, numberings etc. suitable for operation of 415 volts, 3 phase, 4 wire, 50 Hz, AC Supply with enclosure protection class IP 54 complete as required and as specified with the following: <b>(HRV FAN)</b> .				
	<b>(Make - RR Controls/Application/Advance/EAP/ Risha Control)</b>				
	1 No. 40 Amps MCB incoming.				
	1 set 63 Amps triple pole and neutral Aluminium conductor bus bar duly sleeved.				
	2 No. 16 Amps MCB outgoing along with 2 No. DOL starter for HRV exhaust fresh air fan of 1.5 kw each.	Set	1		

14.2	Design, manufacture, supply, installation, testing and commissioning of the MV <b>panel</b> , front operated, cubicle construction, wall mounted type, fabricated out of 2 mm thick CRCA Sheet, Compartmentalized with hinged lockable doors, dust and vermin proof, Powder coated of approved shade after 7 tank treatment, Cable alley, inter-connections, having Switch gear and accessories mounting, internal wiring, earth terminals, Top/ Bottom cable entry, numberings etc. suitable for operation of 415 volts, 3 phase, 4 wire, 50 Hz, AC Supply with enclosure protection class IP 54 complete as required and as specified with the following : <b>(4000 cfm, Axial fan, 1.1 kw motor).</b>				
	1 No. 16 Amps MCCB outgoing along with 1 No. DOL starter for Axial fan..	Set	1		
15	<b><u>Gravity Louvers</u></b>				
	Supplying, fixing, testing and commissioning of 18 Ga G.I. powder coated zero leakage gravity louvers with adjustable nob complete as required and as per specifications.	Sqm	1.0		
	(Make - Aiflow/Servex/Caryaire/Mapro/Tristar/Systemair)				
16	<b><u>Cable Tray</u></b>				
	Supplying and installation of following size of perforated painted with powder coating M.S. cable trays with perforation not more than 17.5%, in convenient sections, joined with connectors, suspended from the ceiling with M.S. suspenders including bolts & nuts, painting suspenders etc. as required.				
	<b>(Make - Feders Lloyd/MEM/Profab/RICO)</b>				
16.1	150 mm width X 50 mm depth X 1.6 mm thickness	RM	30		
17	<b><u>Power Cabling</u></b>				
	Supply & fixing of XLPE insulated, cores laid up, tape innersheathed, armoured aluminium cables for various equipments through walls/ceiling with appropriate clamps & fixing arrangement for running on cable tray, as per specifications and drawings.				
	<b>(Make - Finolex/Skytone/Havells/Rallison/KEI)</b>				
17.1	3C - 4 sqmm	RM	50		
18	<b><u>Earthing</u></b>				
	Supplying and installation of double earthing continuity conductors of G.I. /G.S.S between panel boards and equipments as drawings.				
18.1	Supplying and installation of 6 SWG dia G.I. wire on surface or in recess for loop earthing as required.	Metre	50		
	<b>Total</b>				
	<b>GST @___</b>				
	<b>Total Amount</b>				

**GENERAL NOTES**  
 ALL DIMENSIONS ARE IN MM UNLESS OTHERWISE STATED.  
 ALL DIMENSIONS ARE TO FACE UNLESS OTHERWISE STATED.  
 DO NOT MEASURE THE DRAWING.  
 ALL DRAWINGS ARE TO BE SHOWN IN CONFORMANCE WITH THE APPLICABLE STANDARDS AND REGULATIONS. WHENEVER APPLICABLE, MATERIAL FINISHES ARE TO BE EXPRESSED BY THE ARCHITECT FOR THE RELEVANT CONSULTANTS.

FIXTURES	DESCRIPTION
	LIGHT FIXTURE AS /SAMPLE APP.
	DIFFUSER FOR RETURN
	DIFFUSER FOR SUPPLY
	LIGHT FIXTURE AS PER SAMPLE APP.
	SPEAKER
	SMOKE DETECTOR
	SPRINKLER

**WORKING DRAWING**  
 DESIGN CELL  
 LANDSCAPE  
 HVAC  
 MECHANICAL & ELECTRICAL  
 STRUCTURAL  
 OWNER  
 PROJECT

DESIGN CELL  
 LANDSCAPE  
 HVAC  
 MECHANICAL & ELECTRICAL  
 STRUCTURAL  
 OWNER  
 PROJECT

REVISIONS	NO.	DATE	DESCRIPTION

SCALE	1:40@A1
DATE ISSUED	30-05-2019
DRAWN BY	NITESH
CHECKED BY	JITENDER

**ISSUED FOR**  
 INFORMATION & REVIEW   
 TENDER   
 SUBMISSION   
 GFC   
 AS BUILT

**INCUBATION CENTER-2  
 CORRIDOR LAYOUT AND  
 CEILING PLAN**

IIIITD/LB/INC-ID-01

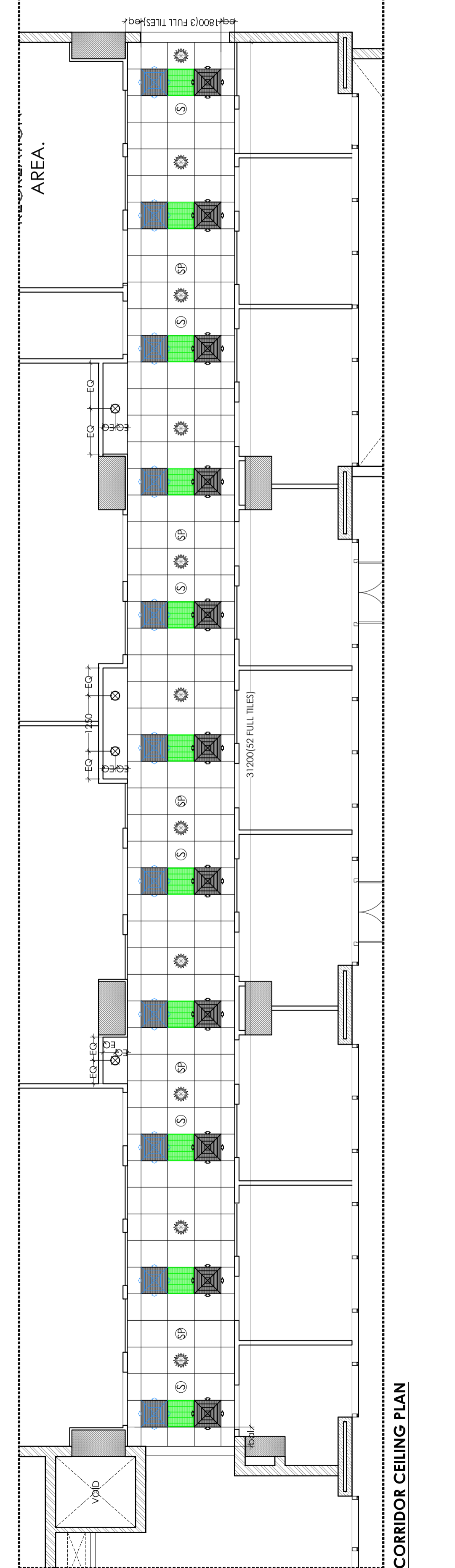
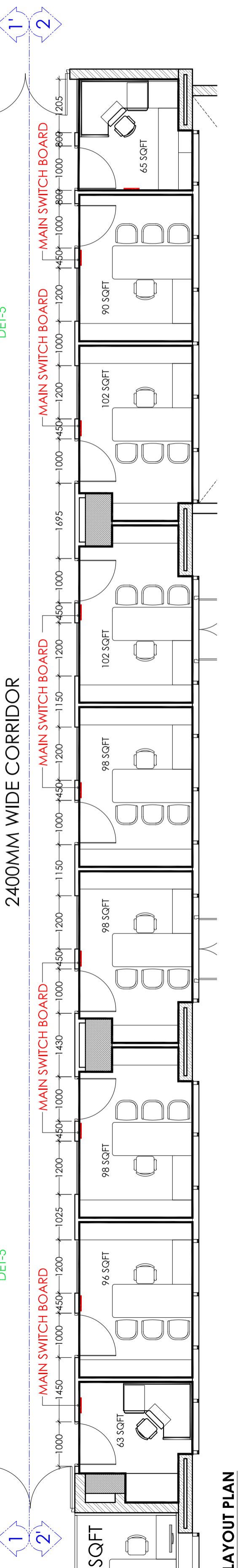
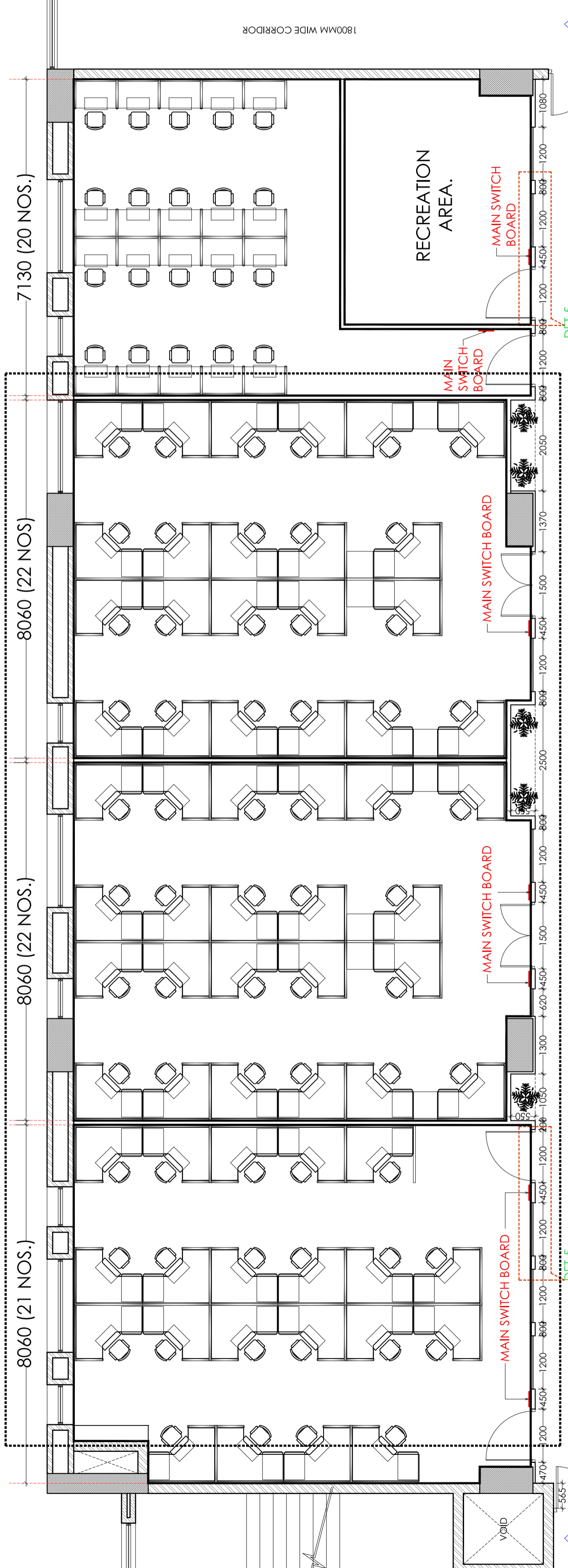

**GENERAL NOTES**  
 ALL DIMENSIONS ARE IN METERS UNLESS OTHERWISE STATED.  
 ALL DIMENSIONS ARE TO FACE UNLESS SPECIFIED OTHERWISE.  
 DO NOT MEASURE THE DRAWING.  
 ALL DIMENSIONS ARE TO BE SHOWN UNLESS OTHERWISE SPECIFIED.  
 ALL DIMENSIONS ARE TO BE SHOWN UNLESS OTHERWISE SPECIFIED.  
 ALL DIMENSIONS ARE TO BE SHOWN UNLESS OTHERWISE SPECIFIED.  
 ALL DIMENSIONS ARE TO BE SHOWN UNLESS OTHERWISE SPECIFIED.

HATCH PATTERN	DESCRIPTION
[Hatch Pattern]	LAMINATE AS/SAMPLE APP.
[Hatch Pattern]	GLASS AS/SAMPLE APP.
[Hatch Pattern]	PAINT AS/SAMPLE APP.
[Hatch Pattern]	TEXTURE PAINT AS/SAMPLE APP.
[Hatch Pattern]	WOODEN SKIRTING AS/SAMPLE APP.

**WORKING DRAWING**

**DESIGN CELL**  
 email: contactus@designcellstudio.com

**Abid Husain**  
 architect  
 contact: abid@abidh.com

**MKG Consultants**  
 email: mkgconsultants@gmail.com

**Engineering Services**  
 email: eservices@eservices.com

**Metro Consultants**  
 A-108, Sakinaka Enclave, New Delhi - 110029  
 Tel: 26106303 / 26121259, Fax: 46226032  
 Email: metro-consultants@metro.com

**INDRAPRASTHA INSTITUTE OF INFORMATION TECHNOLOGY, OKHLA PHASE - III, NEW DELHI - 110028**

**INDRAPRASTHA INSTITUTE OF INFORMATION TECHNOLOGY, OKHLA PHASE - III, NEW DELHI - 110028**

ISSUED FOR	ISSUED FOR
INFORMATION & REVIEW	<input type="checkbox"/>
TENDER	<input type="checkbox"/>
SUBMISSION	<input type="checkbox"/>
GFC	<input checked="" type="checkbox"/>
AS BUILT	<input type="checkbox"/>

REVISIONS	DATE	DESCRIPTION

SCALE	DATE ISSUED	DRAWN BY	CHECKED BY	INCUBATION CENTER-2	CORRIDOR ELEVATIONS	AND DETAILS
1:40@A1	30-05-2019	NITESH	JITENDER	INCUBATION CENTER-2	CORRIDOR ELEVATIONS	AND DETAILS

**SHA**  
 ARCHITECT

**INDRAPRASTHA INSTITUTE OF INFORMATION TECHNOLOGY, OKHLA PHASE - III, NEW DELHI - 110028**

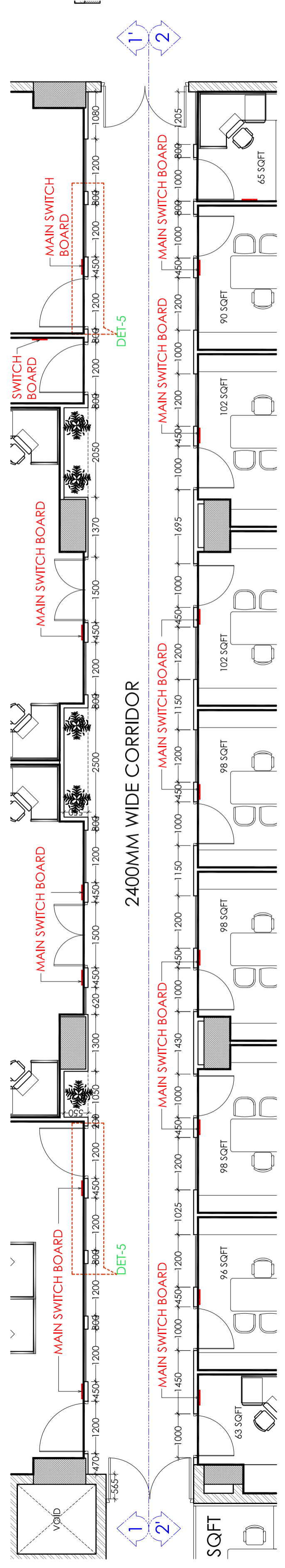

**2400MM WIDE CORRIDOR**

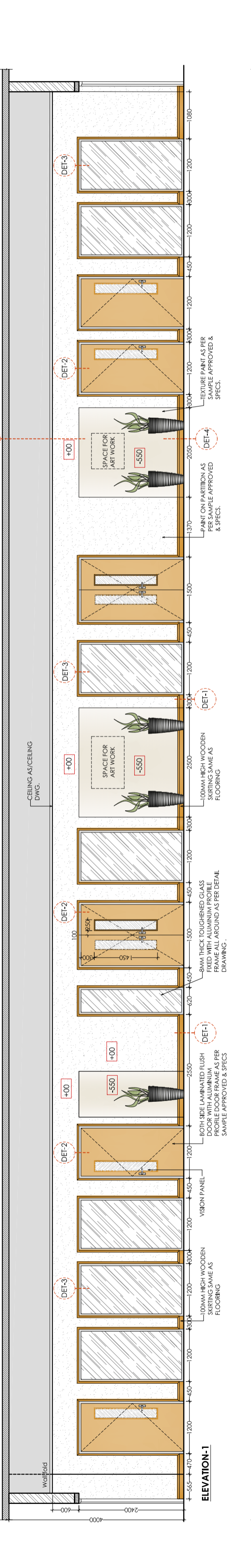

**ELEVATION-1**

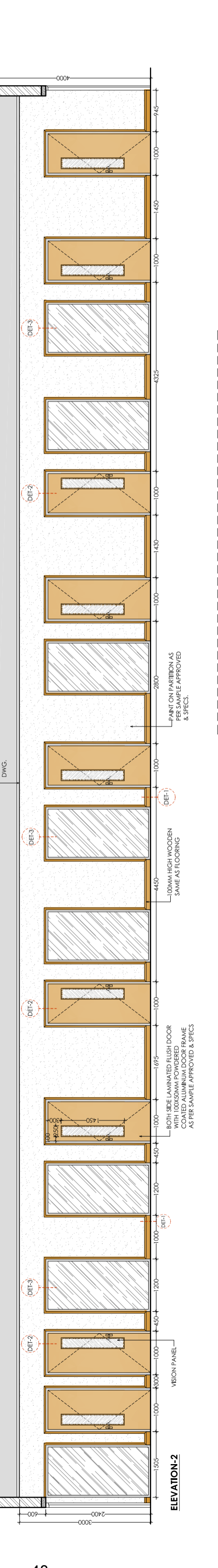

**ELEVATION-2**

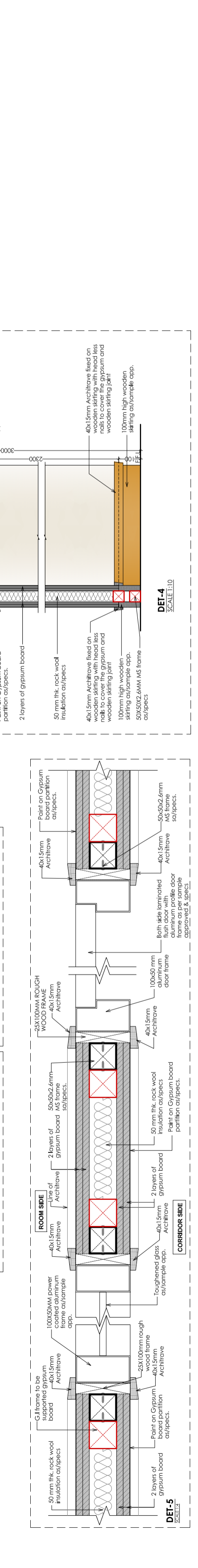
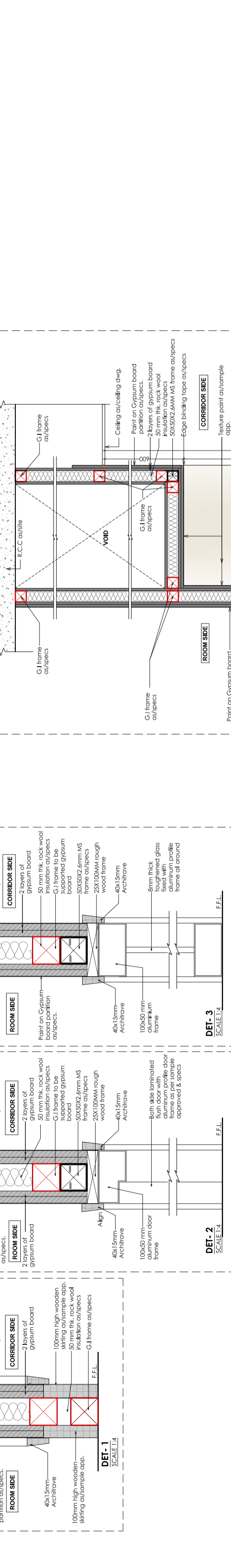

**DEF-5**



**GENERAL NOTES**  
 ALL DIMENSIONS ARE IN MM, UNLESS OTHERWISE STATED.  
 ALL DIMENSIONS TO FACE UNLESS OTHERWISE STATED.  
 DO NOT MEASURE THE DRAWING.  
 ALL DRAWINGS ARE TO BE SHOWN PREVIOUSLY READ ALONG WITH  
 ALL DRAWINGS OF THE PROJECT.  
 ALL FINISHES & CONSTRUCTION DRAWINGS, WHEREVER  
 APPLICABLE.  
 ALL MATERIAL FINISHES ARE TO BE EXPRESSED BY THE ARCHITECT & APPROVED BY  
 THE ARCHITECT & THE RELEVANT CONSULTANTS.

	DIFFUSER FOR RETURN
	DUMMY
	LIGHT FIXTURE AS PER SAMPLE APP
	SPEAKER
	SMOKE DETECTOR
	SPRINKLER

LEGEND	
	F.C. UNIT
	CASSETTE UNIT
	CHWS PIPE
	CHWR PIPE

	DESIGN CELL
Abid Husain	Abid Husain
email:contact@designcell.com	Abid Husain
	MKG Consultants
email:info@mkiconsultants.com	MKG Consultants
	Engineering Services
email:info@esg.com	Engineering Services
Metro Consultants	Metro Consultants
email:info@metro.com	Metro Consultants

INDRAPRASTHA INSTITUTE OF TECHNOLOGY GIRLA PHASE - III, NEW DELHI - 110020	OWNER
INDRAPRASTHA INSTITUTE OF TECHNOLOGY GIRLA PHASE - III, NEW DELHI - 110020	PROJECT
INDRAPRASTHA INSTITUTE OF TECHNOLOGY GIRLA PHASE - III, NEW DELHI - 110020	ARCHITECT
INDRAPRASTHA INSTITUTE OF TECHNOLOGY GIRLA PHASE - III, NEW DELHI - 110020	ISSUED FOR
INDRAPRASTHA INSTITUTE OF TECHNOLOGY GIRLA PHASE - III, NEW DELHI - 110020	ISSUED FOR
INDRAPRASTHA INSTITUTE OF TECHNOLOGY GIRLA PHASE - III, NEW DELHI - 110020	ISSUED FOR
INDRAPRASTHA INSTITUTE OF TECHNOLOGY GIRLA PHASE - III, NEW DELHI - 110020	ISSUED FOR

REVNO.	DATE	DESCRIPTION



SCALE	1 : 75 @ A1	NORTH
DATE ISSUED	13-06-2019	
DRAWN BY	NEYAZ	
CHECKED BY	ADMAN	

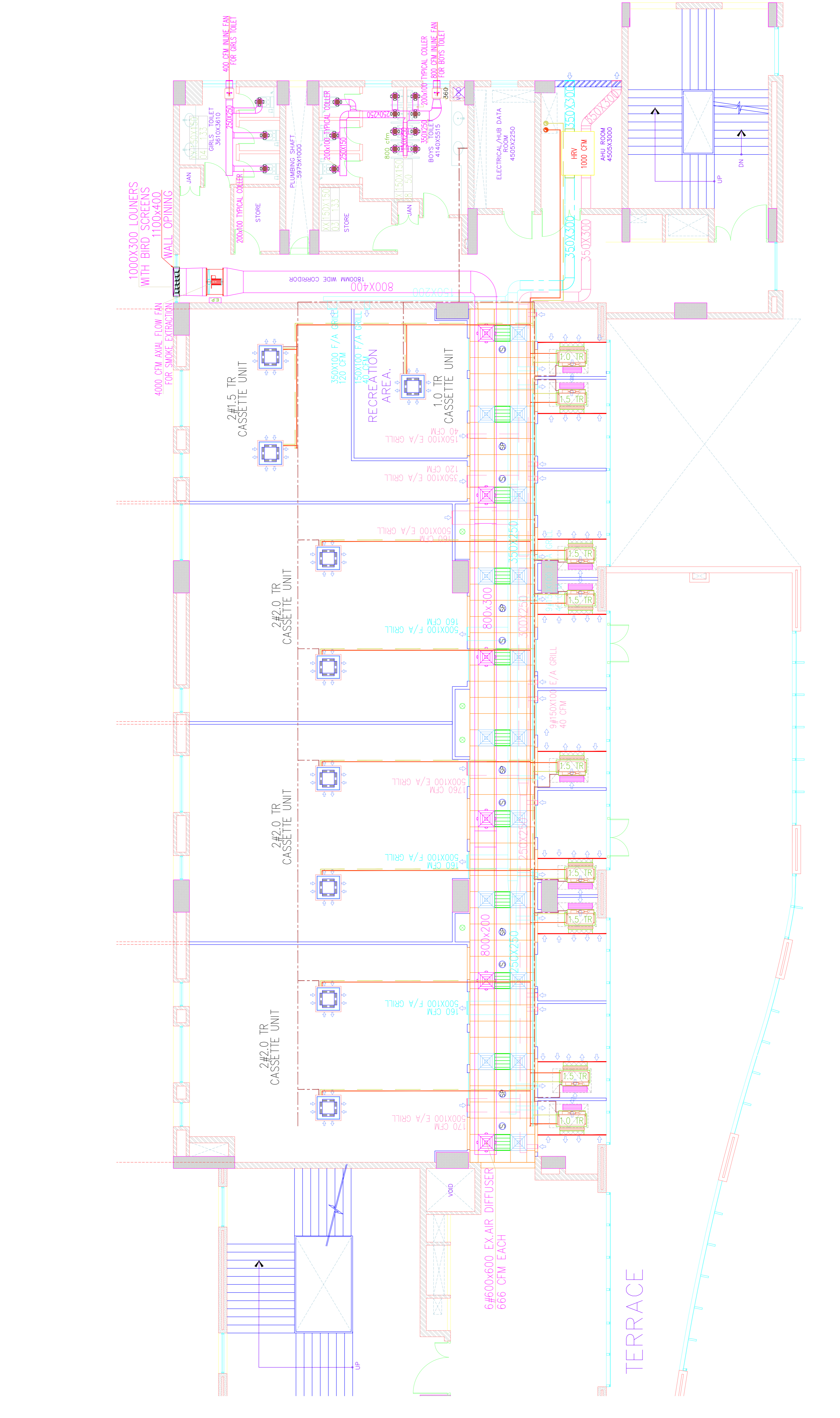



INDRAPRASTHA INSTITUTE OF TECHNOLOGY GIRLA PHASE - III, NEW DELHI - 110020	INCUBATION CENTER-2 CORRIDOR LAYOUT AND CEILING PLAN
--	--

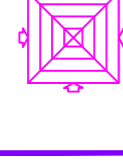
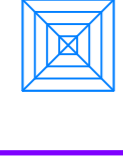

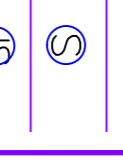
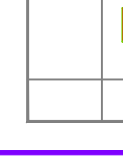
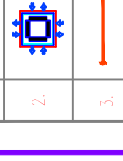
CORRIDOR CEILING PLAN

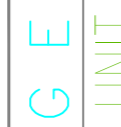
**GENERAL NOTES**  
 ALL DIMENSIONS ARE IN MM UNLESS OTHERWISE STATED.  
 ALL MATERIALS TO BE USED SHALL BE OF THE HIGHEST QUALITY.  
 ALL WORKMANSHIP SHALL BE IN ACCORDANCE WITH THE DRAWINGS.  
 ALL DRAWINGS ARE TO BE SHOWN IN CONJUNCTION WITH THE CONTRACT DOCUMENTS.  
 ALL MATERIALS AND CONSTRUCTION METHODS TO BE USED SHALL BE APPROVED BY THE ARCHITECT & THE RELEVANT CONSULTANTS.  
 ALL MATERIAL FINISHES ARE TO BE EXPRESSED BY THE ARCHITECT & THE RELEVANT CONSULTANTS.

	DIFFUSER FOR RETURN
	DUMMY
	LIGHT FIXTURE AS PER SAMPLE APP
	SPEAKER
	SMOKE DETECTOR
	SPRINKLER

L E G E N D	
	F.C. UNIT
	CASSETTE UNIT
	CHWS PIPE
	CHWR PIPE

ISSUE  
 REVISIONS  
 WORKING DRAWING

DESIGN CELL email: contactus@designcellstudio.com	DESIGN CELL
Abid Husain Consultants email: abid@ahdesigncell.com	
MKG Consultants email: mkgconsultants@gmail.com	
Engineering Consultants email: engcon06@gmail.com	
M/K/O Consultants New Delhi - 110 008 Tel: 26169333 / 26172156 Fax: 46023662 Email: abuhm_mkhof@gmail.com	
INDRAPRASTHA INSTITUTE OF INFORMATION TECHNOLOGY, OKHLA PHASE - III, NEW DELHI - 110020	
DEVELOPMENT OF PHASE III AT INDRAPRASTHA INSTITUTE OF INFORMATION TECHNOLOGY, OKHLA PHASE - III, NEW DELHI - 110020	

**SAA**  
 ARCHITECT

SEAL	ISSUED FOR
	INFORMATION & REVIEW <input type="checkbox"/>
	TENDER <input type="checkbox"/>
	SUBMISSION <input type="checkbox"/>
	GPC <input type="checkbox"/>
	AS BUILT <input type="checkbox"/>

NO.	REVISIONS	DATE	DESCRIPTION

SCALE	NT.S (A1)	NORTH
DATE ISSUED	13-06-2019	
DRAWN BY	NEYAZ	
CHECKED BY	ADNAN	

DWG NO.	SCHEMATIC LAYOUT
DRAWING	INCUBATION CENTER-2 CORRIDOR LAYOUT AND CEILING PLAN
	IIITD/LB/INC/AC-03

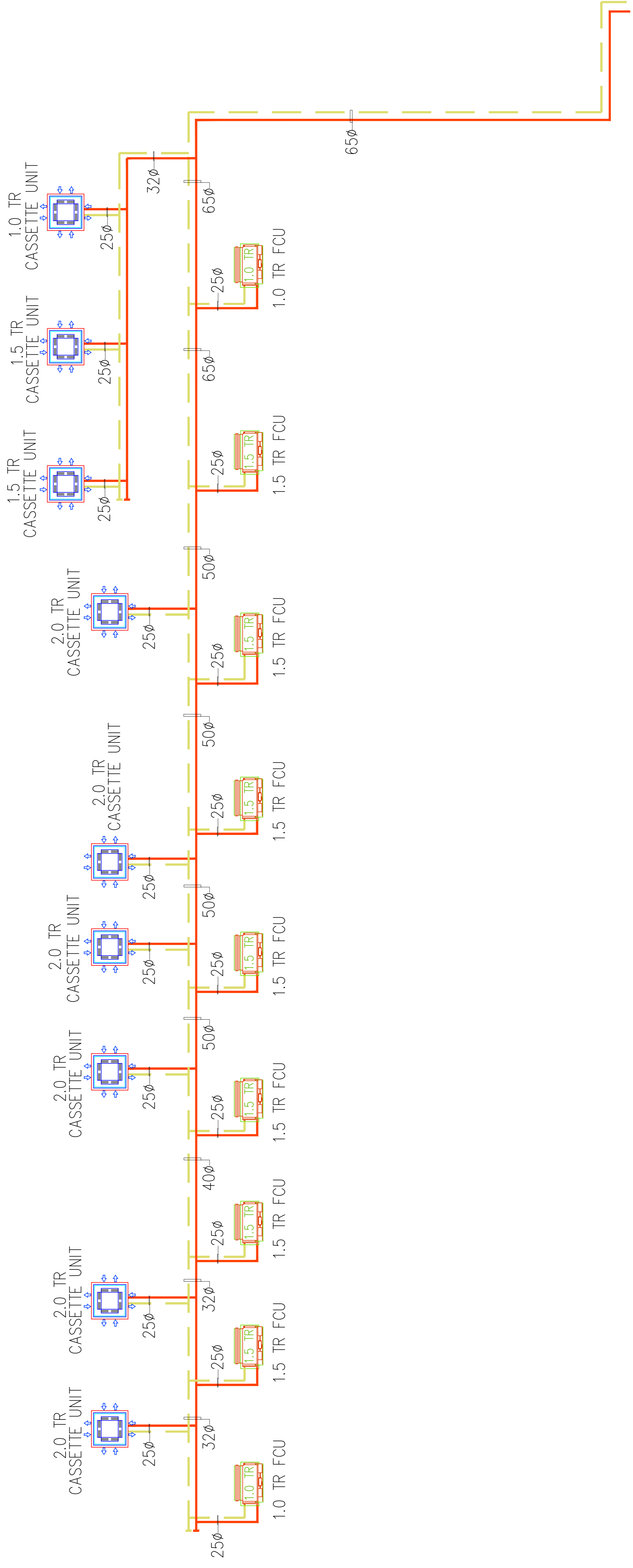

SCHEMATIC LAYOUT